



**Dahua Intelligent Traffic HD Camera  
User's Manual**

**For ITC231-RF1A-IR  
Version 1.0.0**

**ZHEJIANG DAHUA VISION TECHNOLOGY CO.,LTD.**

# Cybersecurity Recommendations

## Mandatory actions to be taken towards cybersecurity

### 1. Change Passwords and Use Strong Passwords:

The number one reason systems get “hacked” is due to having weak or default passwords. It is recommended to change default passwords immediately and choose a strong password whenever possible. A strong password should be made up of at least 8 characters and a combination of special characters, numbers, and upper and lower case letters.

### 2. Update Firmware

As is standard procedure in the tech-industry, we recommend keeping NVR, DVR, and IP camera firmware up-to-date to ensure the system is current with the latest security patches and fixes.

## “Nice to have” recommendations to improve your network security

### 1. Change Passwords Regularly

Regularly change the credentials to your devices to help ensure that only authorized users are able to access the system.

### 2. Change Default HTTP and TCP Ports:

- Change default HTTP and TCP ports for systems. These are the two ports used to communicate and to view video feeds remotely.
- These ports can be changed to any set of numbers between 1025-65535. Avoiding the default ports reduces the risk of outsiders being able to guess which ports you are using.

### 3. Enable HTTPS/SSL:

Set up an SSL Certificate to enable HTTPS. This will encrypt all communication between your devices and recorder.

### 4. Enable IP Filter:

Enabling your IP filter will prevent everyone, except those with specified IP addresses, from accessing the system.

### 5. Change ONVIF Password:

On older IP Camera firmware, the ONVIF password does not change when you change the system’s credentials. You will need to either update the camera’s firmware to the latest revision or manually change the ONVIF password.

### 6. Forward Only Ports You Need:

- Only forward the HTTP and TCP ports that you need to use. Do not forward a huge range of numbers to the device. Do not DMZ the device's IP address.
- You do not need to forward any ports for individual cameras if they are all connected to a recorder on site; just the NVR is needed.

### 7. Disable Auto-Login on SmartPSS:

Those using SmartPSS to view their system and on a computer that is used by multiple people should disable auto-login. This adds a layer of security to prevent users without the appropriate credentials from accessing the system.

### 8. Use a Different Username and Password for SmartPSS:

In the event that your social media, bank, email, etc. account is compromised, you would not want someone collecting those passwords and trying them out on your video

surveillance system. Using a different username and password for your security system will make it more difficult for someone to guess their way into your system.

#### **9. Limit Features of Guest Accounts:**

If your system is set up for multiple users, ensure that each user only has rights to features and functions they need to use to perform their job.

#### **10. UPnP:**

- UPnP will automatically try to forward ports in your router or modem. Normally this would be a good thing. However, if your system automatically forwards the ports and you leave the credentials defaulted, you may end up with unwanted visitors.
- If you manually forwarded the HTTP and TCP ports in your router/modem, this feature should be turned off regardless. Disabling UPnP is recommended when the function is not used in real applications.

#### **11. SNMP:**

Disable SNMP if you are not using it. If you are using SNMP, you should do so only temporarily, for tracing and testing purposes only.

#### **12. Multicast:**

Multicast is used to share video streams between two recorders. Currently there are no known issues involving Multicast, but if you are not using this feature, deactivation can enhance your network security.

#### **13. Check the Log:**

If you suspect that someone has gained unauthorized access to your system, you can check the system log. The system log will show you which IP addresses were used to login to your system and what was accessed.

#### **14. Physically Lock Down the Device:**

Ideally, you want to prevent any unauthorized physical access to your system. The best way to achieve this is to install the recorder in a lockbox, locking server rack, or in a room that is behind a lock and key.

# Foreword

## General









This user's manual (hereinafter referred to be "the Manual") introduces the functions and operations of the ITC devices (hereinafter referred to be "the Device").

## Models

ITC231-RF1A-IR

## Safety Instructions

The following categorized signal words with defined meaning might appear in the Manual.

Signal Words	Meaning
 <b>DANGER</b>	Indicates a high potential hazard which, if not avoided, will result in death or serious injury.
 <b>WARNING</b>	Indicates a medium or low potential hazard which, if not avoided, could result in slight or moderate injury.
 <b>CAUTION</b>	Indicates a potential risk which, if not avoided, may result in property damage, data loss, lower performance, or unpredictable result.
 <b>ELECTRICITY</b>	Indicates dangerous high voltage. Take care to avoid coming into contact with electricity.
 <b>LASER BEAM</b>	Indicates a laser radiation hazard. Take care to avoid exposure to a laser beam.
 <b>ESD</b>	Electrostatic Sensitive Devices. Indicates a device that is sensitive to electrostatic discharge.
 <b>TIPS</b>	Provides methods to help you solve a problem or save you time.
 <b>NOTE</b>	Provides additional information as the emphasis and supplement to the text.

## Revision History

No.	Version	Revision Content	Release Time
1	V1.0.0	First Release.	March, 2018

## About the Manual

- The Manual is for reference only. If there is inconsistency between the Manual and the actual product, the actual product shall govern.
- All the designs and software are subject to change without prior written notice. The product updates might cause some differences between the actual product and the Manual. Please contact the customer service for the latest program and supplementary documentation.
- There still might be deviation between the actual value of some data and the value provided, if there is any doubt or dispute, please refer to our final explanation.
- Please contact the supplier or customer service if there is any problem occurred when using the device.
- We are not liable for any loss caused by the operations that do not comply with the Manual.
- All trademarks, registered trademarks and the company names in the Manual are the properties of their respective owners.
- Please visit our website or contact your local service engineer for more information.
- If there is any uncertainty or controversy, please refer to our final explanation.

# Important Safeguards and Warnings

## Electrical safety

- All installation and operation here should conform to your local electrical safety codes.
- The product must be grounded to reduce the risk of electric shock.

We assume no liability or responsibility for all the fires or electrical shock caused by improper handling or installation.

## Transportation security

Heavy stress, violent vibration or water splash are not allowed during transportation, storage and installation.

## Installation

- Keep upwards. Handle with care.
- Do not apply power to the Device before completing installation.
- Do not place objects on the Device.

## Qualified engineers needed

All the examination and repair work should be done by the qualified service engineers. We are not liable for any problems caused by unauthorized modifications or attempted repair.

## Environment

The Device should be installed in a cool, dry place away from conditions such as direct sunlight, inflammable substances, and explosive substances.

## Accessories

- Be sure to use all the accessories recommended by manufacturer.
- Before installation, please open the package and check all the components are included.
- Contact your local retailer ASAP if something is broken in your package.

## Lithium battery

- Improper battery use might result in fire, explosion, or personal injury.
- When replacing the battery, please make sure you are using the same type. Risk of explosion if battery is replaced by an incorrect type.

Dispose of used batteries according to the instructions.

# Table of Contents

Cybersecurity Recommendations .....	II
Foreword .....	IV
Important Safeguards and Warnings .....	i
1 General Introduction .....	1
1.1 Overview .....	1
1.2 Features.....	1
2 Device Structure .....	3
2.1 Rear Panel .....	3
2.2 Side Panel .....	5
2.3 Front Panel .....	5
3 Installation .....	6
3.1 Install Lens.....	6
3.1.1 Install Auto Iris Lens .....	7
3.1.2 Install Manual Iris Lens .....	7
3.1.3 Remove Lens .....	7
3.2 TF card Installation .....	7
3.2.1 Installation .....	7
3.2.2 Remove TF card.....	8
3.3 I/O Port .....	9
3.3.1 Install Cable.....	9
3.3.2 Remove Cable.....	9
4 System Network .....	10
5 Quick Configuration Tool.....	12
5.1 Change IP Address.....	12
5.2 Upgrade Device .....	13
5.3 Login WEB.....	15
5.4 Search Setting .....	16
6 Web Operation .....	17
6.1 Intro to WEB.....	17
6.1.1 First Time Login .....	17
6.1.2 Non-First Time Login .....	19
6.1.3 Function.....	19
6.2 Live .....	20
6.2.1 Video Bit Stream Bar .....	20
6.2.2 Preview Window Switch.....	21
6.2.3 Common Function Bar.....	21
6.2.4 Monitor Window Switch .....	22

6.3	Guide .....	22
6.3.1	Plate-pixel Check.....	23
6.3.2	Trigger Mode .....	24
6.3.3	Lamp Config .....	26
6.3.4	Lane Property .....	28
6.3.5	Complete .....	29
6.4	Query .....	29
6.4.1	Picture Query.....	29
6.4.2	Flow Query .....	32
6.4.3	Record Query .....	33
6.5	Configure .....	35
6.5.1	ITC.....	35
6.5.2	Camera.....	57
6.5.3	Network .....	66
6.5.4	Event .....	78
6.5.5	Storage.....	85
6.5.6	System.....	90
6.5.7	Information.....	99
6.6	Alarm .....	102
6.7	Logout.....	103
7	FAQ.....	104



# 1 General Introduction

## 1.1 Overview

Intelligent Traffic HD IR ANPR camera as the core monitoring device in a road monitoring system, adopts embedded operating systems, advanced compression technology H.265 encoding, flexible snapshot.

The product monitors different roads, and sends the video data to client, server, back-end storage devices through the network.

The products are widely used in high speed, metro and waterways safety monitoring system, effectively reduce speeding vehicle, run on red light record, retrogradation driving and other illegal behaviors, provide effective management tools for modern traffic management.

## 1.2 Features

**Note:**

**The following lists out some functions of the device, which is for reference only. Different models of product may have different functions.**

<b>Cutout</b>	<ul style="list-style-type: none"><li>● When it snapshots one vehicle, it also cutout plate part of that snapshot. ANPR camera can cutout driver and co-driver photo.</li></ul>
<b>Recognition</b>	<ul style="list-style-type: none"><li>● Support plate, vehicle color recognition function.</li><li>● Support retrogradation, over speed, unfastened seat belt detection.</li></ul>
<b>User Management</b>	<ul style="list-style-type: none"><li>● Different user rights for each group and you may modify the setup anytime.</li><li>● Search of online user.</li></ul>
<b>Log Management</b>	<ul style="list-style-type: none"><li>● Support 1024 log.</li><li>● Support account right setup.</li></ul>
<b>Storage</b>	<ul style="list-style-type: none"><li>● According to user needs by WEB recording mode, video files on the client computer resides.</li><li>● Support local TF card storage, hot-swap capability, support resume broken network. When there is insufficient memory storage space, you can automatically cycle cover image storage.</li></ul>
<b>Alarm</b>	<ul style="list-style-type: none"><li>● For camera abnormality, it can send alarm via network, such as storage damage.</li><li>● Real-time respond to external alarm input( within 200MS) as user pre-defined activation setup and exert corresponding message in screen and audio prompt(allow user to pre-record audio file).</li></ul>
<b>Network Monitor</b>	<ul style="list-style-type: none"><li>● Via network, it can send single channel video compressed by the device to network terminal and decompress it.</li><li>● Max supports 10 connections.</li><li>● Adopt the following video data transmission protocol: HTTP, TCP, UDP, MULTICAST and RTP/RTCP and etc.</li></ul>

	<ul style="list-style-type: none"> <li>● Support web access, widely used in WAN.</li> </ul>
<b>Vehicle Flow Statistics</b>	<ul style="list-style-type: none"> <li>● Dock with signal device to count traffic flow.</li> </ul>
<b>Snapshot</b>	<ul style="list-style-type: none"> <li>● Picture snapshot and encode.</li> <li>● Watermark on picture.</li> <li>● User can set speed limit and interval of snapshot.</li> <li>● Snapshot automatically record vehicle time, location, speed, limit of speed, lane no., picture no., violation and etc.</li> <li>● Snapshot violation.</li> </ul>
<b>Link Record</b>	<ul style="list-style-type: none"> <li>● Link record to violation.</li> </ul>
<b>OSD Setup</b>	<ul style="list-style-type: none"> <li>● Set OSD info and position of video channel, picture and mosaic picture.</li> </ul>
<b>Network Management</b>	<ul style="list-style-type: none"> <li>● Via Ethernet manage device config and control right.</li> <li>● Manage device via WEB</li> </ul>
<b>Peripheral Equipment</b>	<ul style="list-style-type: none"> <li>● Support peripheral equipment management, each peripheral equipment control protocol and interface can be set freely.</li> <li>● Support external NO light which can be triggered.</li> </ul>
<b>Power Supplying</b>	<ul style="list-style-type: none"> <li>● Support DC 12V input.</li> </ul>
<b>White Balance</b>	<ul style="list-style-type: none"> <li>● Auto white balance refers to the camera to restore the white object color. It allows the camera to adjust the color temperature in indoor and outdoor environment.</li> <li>● Partial white balance: refer to environment, adjust target color.</li> </ul>
<b>Auto Exposure</b>	<ul style="list-style-type: none"> <li>● System can automatically set shutter speed and iris value according to the snapshot video exposure condition.</li> </ul>
<b>Auto Gain</b>	<ul style="list-style-type: none"> <li>● The system can enhance the camera sensitivity in low illumination and enhance the video signal output to get the clear and high definition video.</li> </ul>
<b>Assistant Function</b>	<ul style="list-style-type: none"> <li>● Support video watermark function to avoid vicious video modification.</li> <li>● Support system resource info and operation status real time display and log.</li> <li>● NO light signal control and output.</li> <li>● GPS positioning.</li> </ul>

## 2 Device Structure

### 2.1 Rear Panel

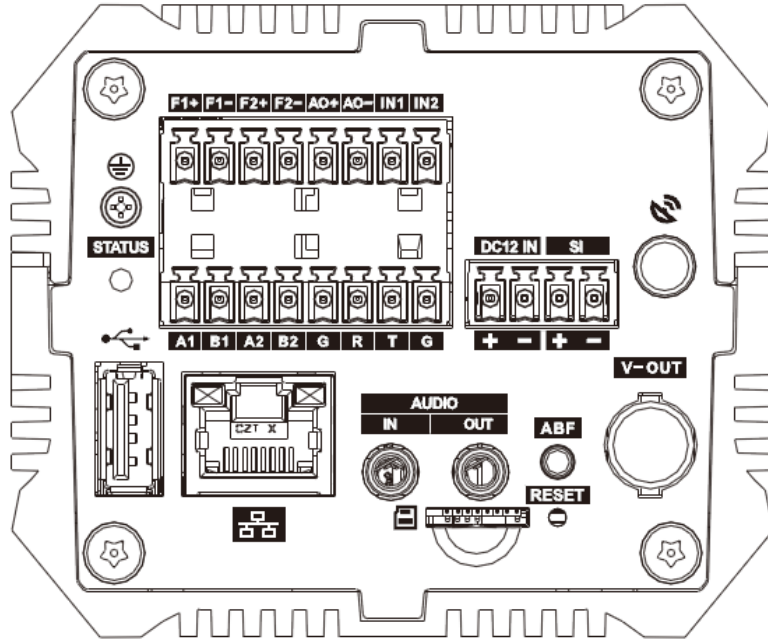



Figure 2- 1

Interface Name		Function
	GND	This interface must be grounded, to improve device reliability, otherwise the device may lose lightning protection.
STATUS	Status indication light	It is to indicate camera working status: <ul style="list-style-type: none"> <li>● The blue light flashes when recording.</li> <li>● The red light flashes when system is upgrading.</li> <li>● The red light flashes in safety mode.</li> </ul>
F1+, F1-, F2+, F2-, AO1, AO2	3-ch output interface	Switch, may set output flashlight signal and strobe light signal. Warning: Page config must match actual light, otherwise the light could be damaged.
IN1, IN2	IO input interface	Provide 4 IO trigger snapshot interfaces or 4 alarm input interfaces
A1	RS485 interface	RS485_A1 interface, this device is used to control NO light, and others may expand to customize signal detector, vehicle detector and etc.





Interface Name		Function
B1		RS485_B1 interface, this device is used to control NO light, and others may expand to customize signal detector, vehicle detector and etc.
A2		RS485_A2 interface, this camera is used to control 485 focus lens, expand to customize other 485 control peripheral, such as external NO light.
B2		RS485_B2 interface, this camera is used to control 485 focus lens, expand to customize other 485 control peripheral, such as external NO light.
R	RS232 serial	RS232_RX, RS232 serial receiver end
T		RS232_TX, RS232 serial sender end
G	GND	Grounding
DC 12 IN	Power input interface	Input 12V DC
SI	External frequency source sync input interface	Camera sync external signal source (select external sync option, it take effective immediately, voltage range 12 Vp-p~36 Vp-p or AC 12V~AC 24V)
	GPS	External GPS antenna
	1 USB interface	Used to expand 3G, 4G and Wi-Fi
	1 network interface	Connect to standard Ethernet
AUDIO IN/OUT	Audio input/output	Audio input/output interface
ABF	Auto focus	Auto focus
RESET	Reset	Restore default settings. Under normal work status (power indicator is blue), hold this button for 5 seconds, system info will be restored.
V-OUT	Video output CVBS	CVBS (1.0Vp-p, 75Ω) .
	TF card port	<p>TF card connection. TF card use:</p> <ul style="list-style-type: none"> <li>● When install TF card, make sure TF card is not write-protected status and then inserted into the TF card slot.</li> <li>● When remove the TF card, make sure the TF card is a non-write state, otherwise it may cause data loss and TF card damage.</li> <li>● When hot-swap TF card, stop recording after the operation.</li> </ul>

Chart 2-1

## 2.2 Side Panel

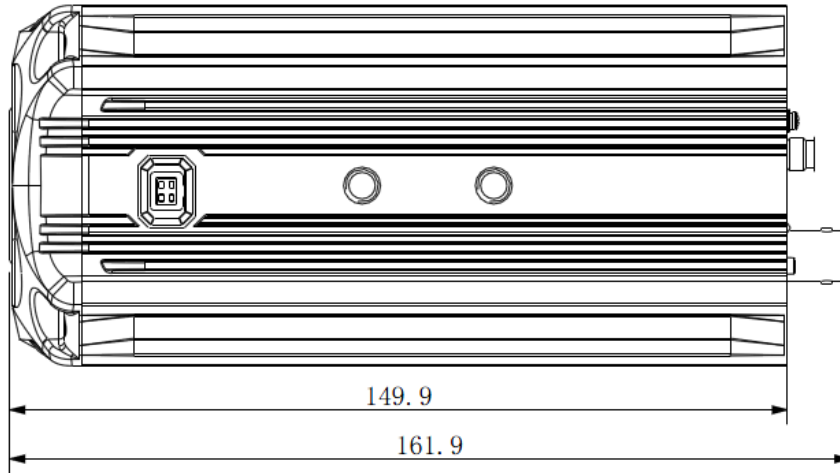

Figure 2- 2

## 2.3 Front Panel

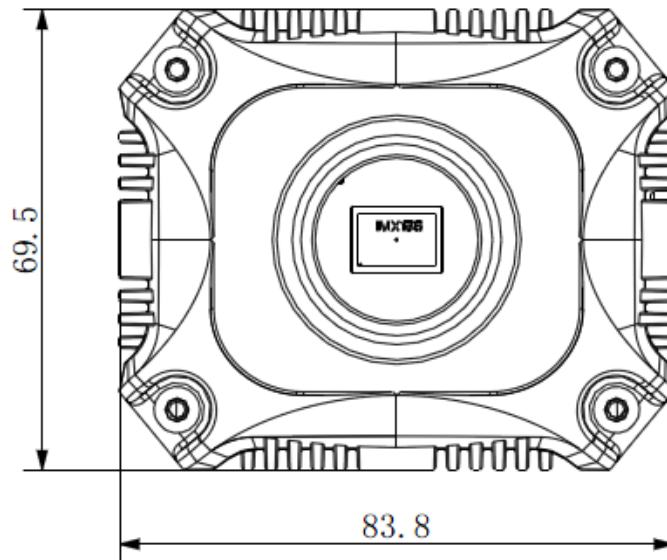

Figure 2- 3

### 3 Installation

#### Warning:

To ensure the device is normally grounded and improve device reliability, please connect  port of device to the ground.

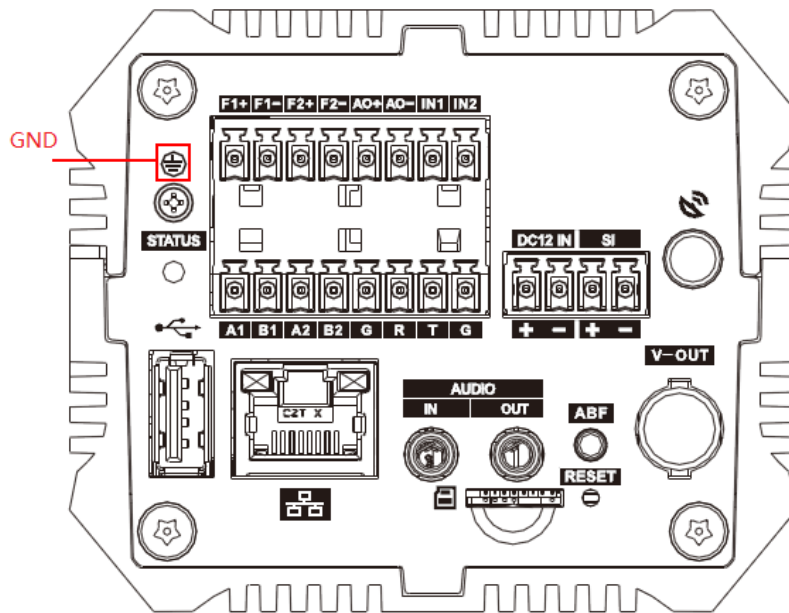

Figure 3- 1

#### 3.1 Install Lens

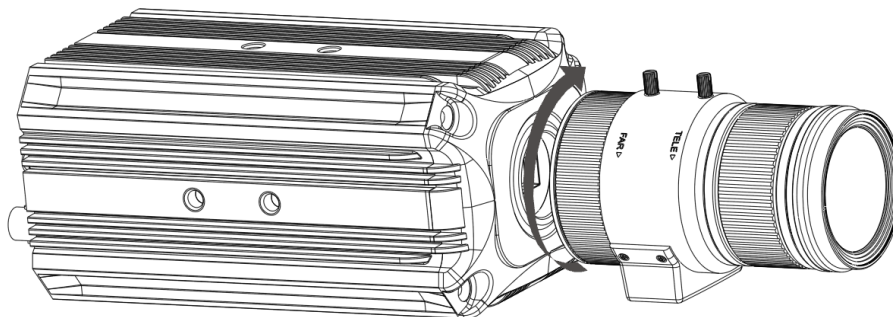

Figure 3- 2

### 3.1.1 Install Auto Iris Lens

- Step 1. Remove the Sensor protective cover on the device.
- Step 2. Aim the lens at the mounting position of the lens on the camera, rotate the lens clockwise until it is securely in place.
- Step 3. Insert the plug of the lens cable to the auto iris lens connector on the side panel of the camera.
- Step 4. Adjust the focus so that the image is clear.

### 3.1.2 Install Manual Iris Lens

Make model C lens as an example:

- Step 1. First remove the cover on the Sensor protective equipment.
- Step 2. Use cross screwdriver to unfasten screw next to focusing ring, aim the lens at the mounting position of the lens on the camera, rotate the lens clockwise until it is securely in place.
- Step 3. Counterclockwise rotate the focusing ring until it is out for several mm and manually focusing.
- Step 4. Use cross screwdriver to fasten screw, fixing focusing ring.

### 3.1.3 Remove Lens

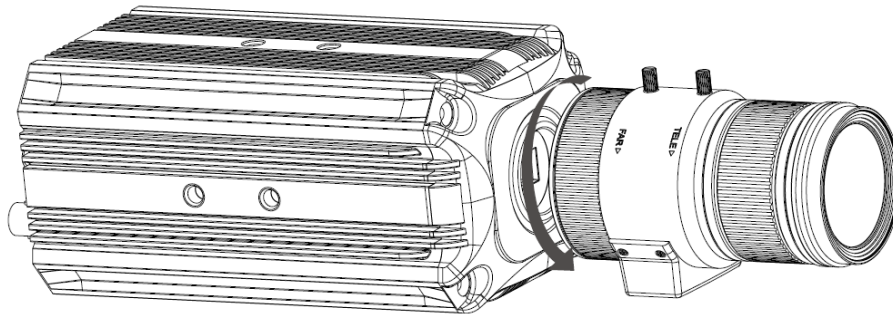

Figure 3- 3

- Step 1. Unplug the auto lens cable socket from the auto lens connector. If you are using the manual aperture lens, please skip to the following step.
- Step 2. Turn the lens counter clockwise and then remove it from the camera.
- Step 3. Please put the Sensor protection cap back to protect the front.

## 3.2 TF card Installation

**Note:**

Here is just an example, please subject to actual model.

### 3.2.1 Installation

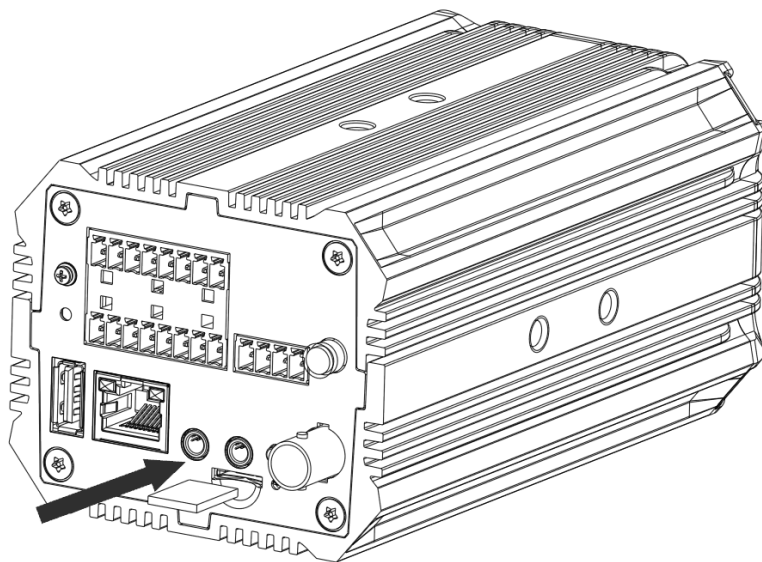

Figure 3- 4

Install the TF card into the camera according to the proper installation position.

### 3.2.2 Remove TF card

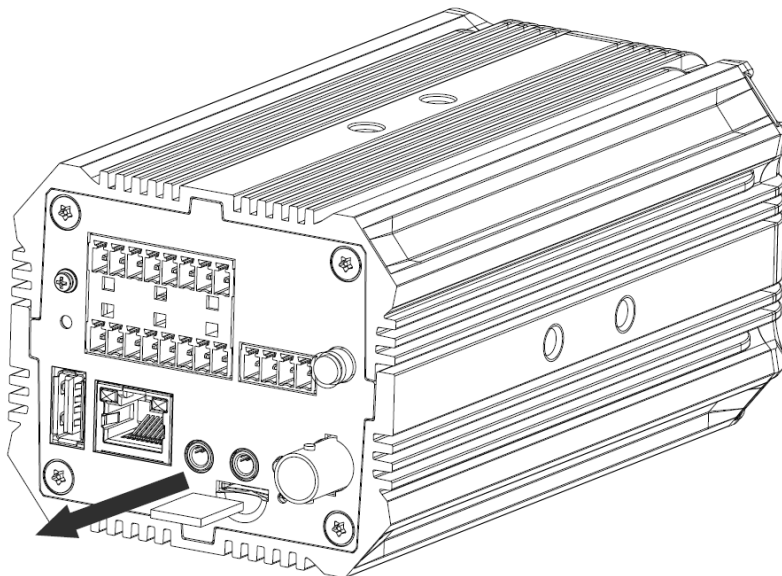

Figure 3- 5

Follow the TF card direction to remove the TF card from the device.



## 3.3 I/O Port

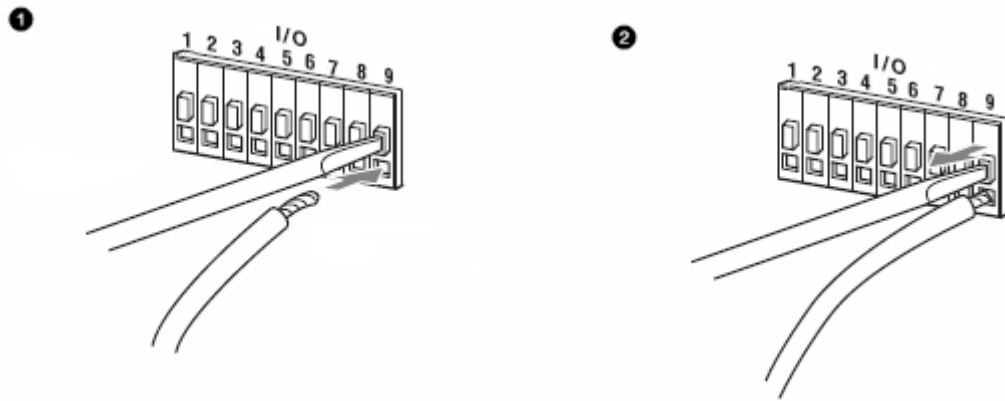

Figure 3- 6

### 3.3.1 Install Cable

Step 1. Use the small slotted screwdriver to press the corresponding button of cable groove.

Step 2. Insert the cable into the groove.

Step 3. Release the screwdriver.

### 3.3.2 Remove Cable

Step 1. Use the small slotted screwdriver to press the corresponding button of cable groove.

Step 2. Remove the cable out of the groove.

Step 3. Release the screwdriver.

# 4 System Network

Please refer to Figure 4-1.

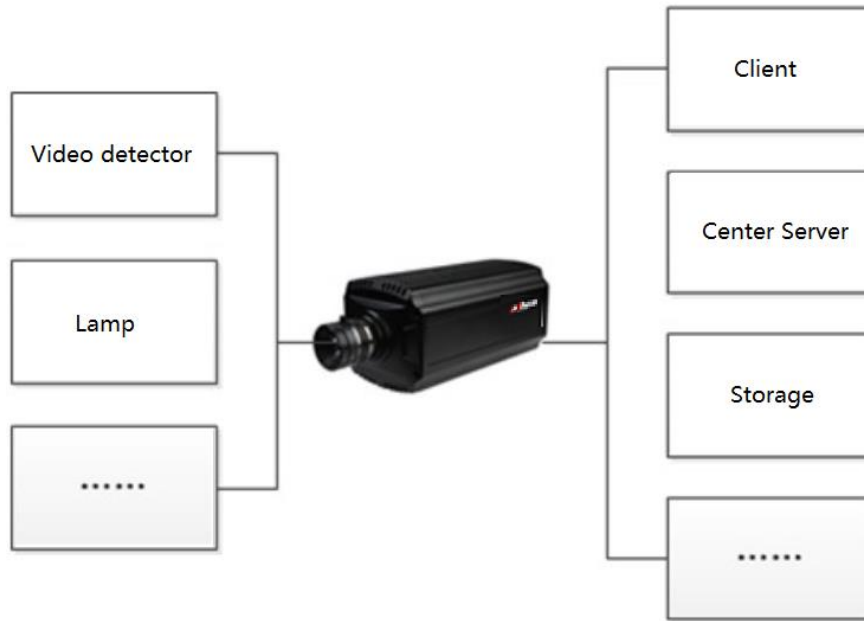

Figure 4-1

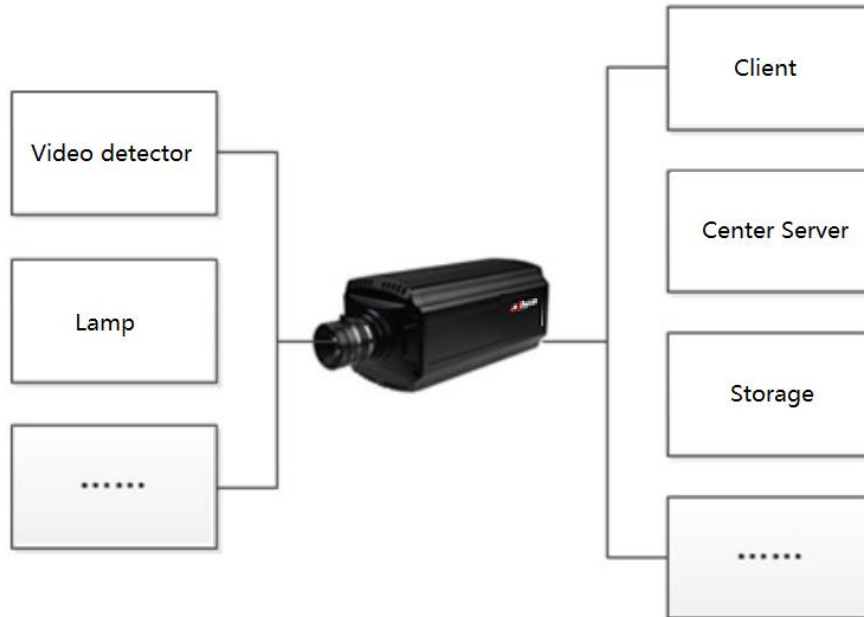

Figure 4-2



## 5 Quick Configuration Tool

By downloading and sign in Dahua Tool, you can get Quick Config Tool.

Quick configuration tool can search current IP address, modify IP address. At the same time, you can use it to upgrade the device.

**Note:**

**This manual makes ConfigTool 4.09.0 as an example. Please be aware that different versions may have different operation interfaces.**

Double click the “DH\_ConfigTool.exe” icon, you can see an interface is shown as in Figure 5-1.

In the device list interface, you can view device IP address, port number, subnet mask, default gateway, MAC address and etc.

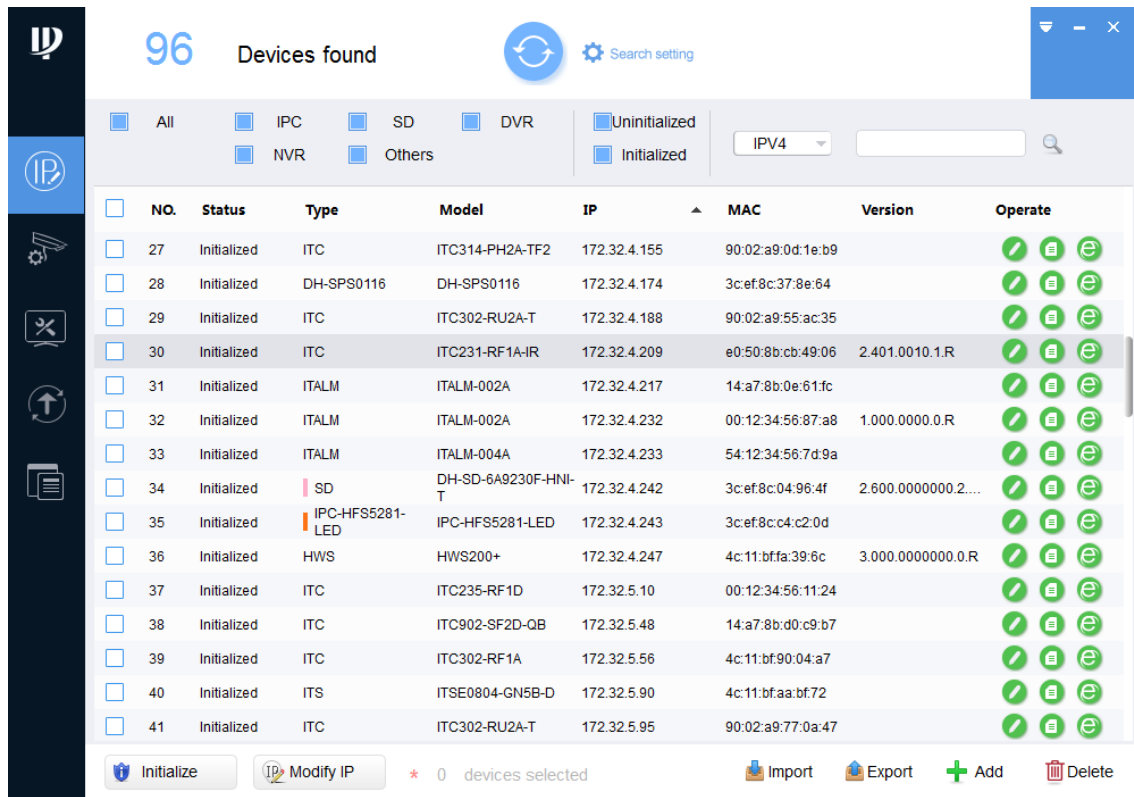



Figure 5-1

### 5.1 Change IP Address

Step 1. Open Quick Config Tool.

Step 2. Click , see “Modify IP Address” interface.

Step 3. Select device to modify IP.

- Single: Click  of target device to change its IP.
- Batch modify: select device to change its IP, and click Modify IP.

Step 4. Set mode, IP, subnet mask and gateway.

Note:

When you modify IP, select “Same IP” as to set all IPs to the same one.

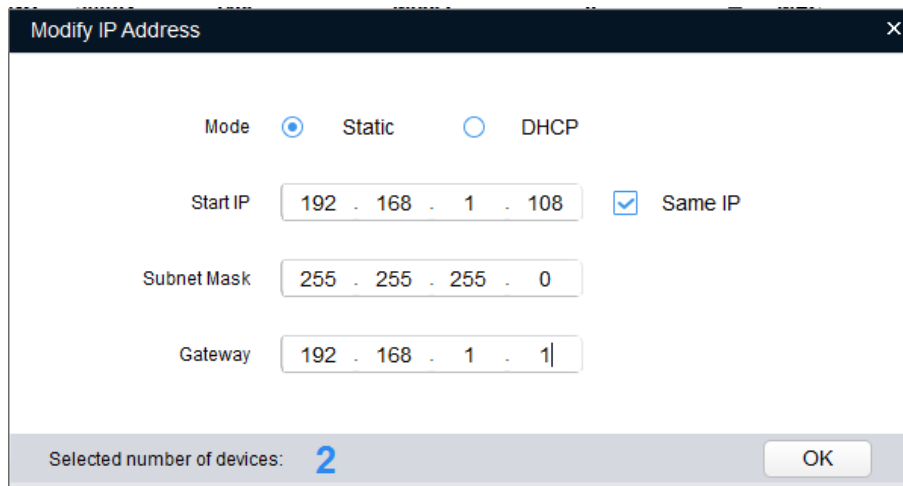

Modify IP Address

Mode  Static  DHCP

Start IP 192 . 168 . 1 . 108  Same IP

Subnet Mask 255 . 255 . 255 . 0

Gateway 192 . 168 . 1 . 1

Selected number of devices: 2 OK

Figure 5-2

Step 5. Click OK.

## 5.2 Upgrade Device

It supports single or batch upgrade device.

Step 1. Open Quick Config Tool.

Step 2. Click , see Figure 5-3.

97 Devices found

Search setting

All
  IPC
  SD
  DVR
  NVR
  Others

<input type="checkbox"/>	NO.	Type	IP	Version	Upgrade File Path	Browse	Operate
<input type="checkbox"/>	1	DH-SPS0116	172.32.4.174			Browse	Upgrade
<input type="checkbox"/>	2	ITC	192.168.1.108	2.302.0.1		Browse	Upgrade
<input type="checkbox"/>	3	ITC602-SF1A-QA	172.32.4.44			Browse	Upgrade
<input type="checkbox"/>	4	ITC	172.32.4.55	2.302.0.0		Browse	Upgrade
<input type="checkbox"/>	5	ITC602-RF1A	172.32.4.33			Browse	Upgrade
<input type="checkbox"/>	6	ITC206-RF1A	172.32.4.35			Browse	Upgrade
<input type="checkbox"/>	7	IPC-HFS5281-...	172.32.4.243			Browse	Upgrade
<input type="checkbox"/>	8	ITC523-CEVRB3A	172.32.5.113			Browse	Upgrade
<input type="checkbox"/>	9	ITSE	172.32.100.185			Browse	Upgrade
<input type="checkbox"/>	10	ITS	172.32.4.46	1.0.0.0		Browse	Upgrade
<input type="checkbox"/>	11	ITC	172.32.8.108			Browse	Upgrade
<input type="checkbox"/>	12	ITC	172.32.5.48			Browse	Upgrade
<input type="checkbox"/>	13	ITC	172.32.8.105			Browse	Upgrade
<input type="checkbox"/>	14	ITC	172.32.5.135			Browse	Upgrade
<input type="checkbox"/>	15	ITALM	172.32.4.217			Browse	Upgrade

Batch Upgrade \* 0 devices selected

Figure 5-3

Step 3. Select device to upgrade.

- Single: click “Browse” of device you want to upgrade.
- Batch: select device you want to upgrade, and click “Batch Upgrade”.

Step 4. Select upgrade file, see Figure 5-4.

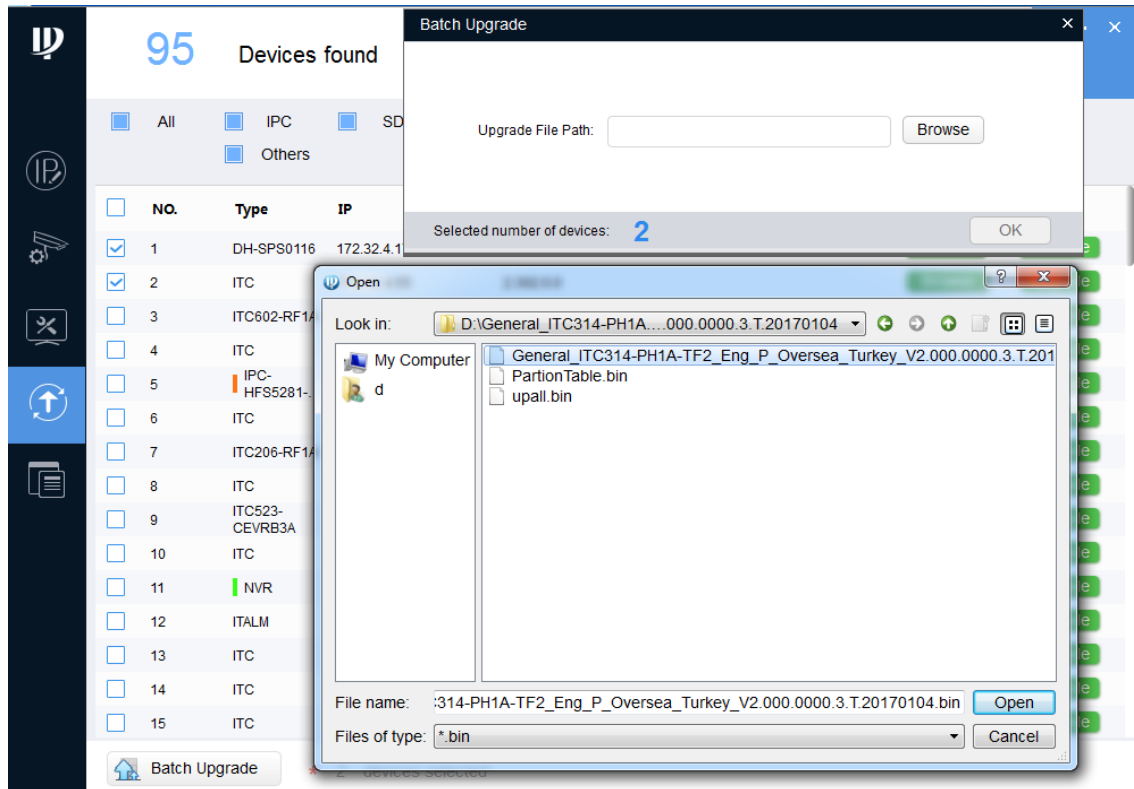

Figure 5-4

Step 5. Upgrade device.

- Single: click “Upgrade”, and system shows progress.
- Batch: click OK so system starts to upgrade.

Note:

During upgrading, as long as ConfigTool stays in upgrade interface, when device connects again, the upgrading will continue.

### 5.3 Login WEB

- Click  in device row, to login WEB page. See Figure 5-5.

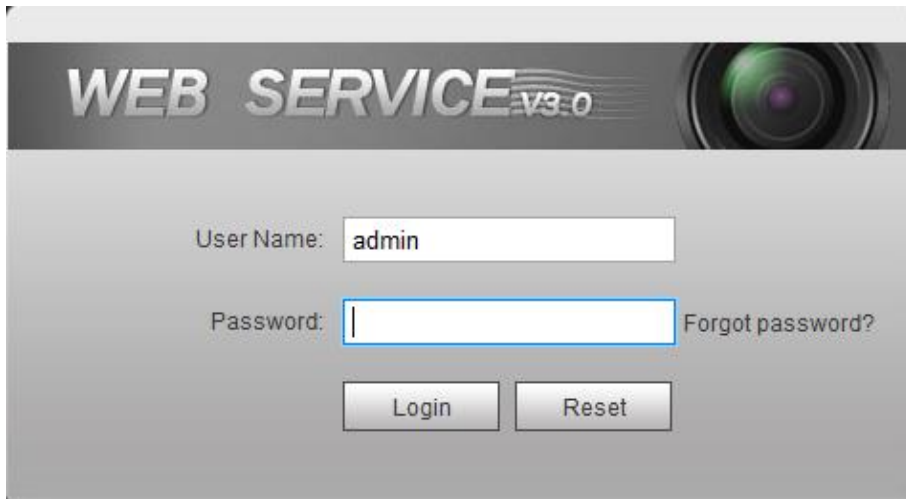

Figure 5-5

## 5.4 Search Setting

Click  [Search setting](#), search device.

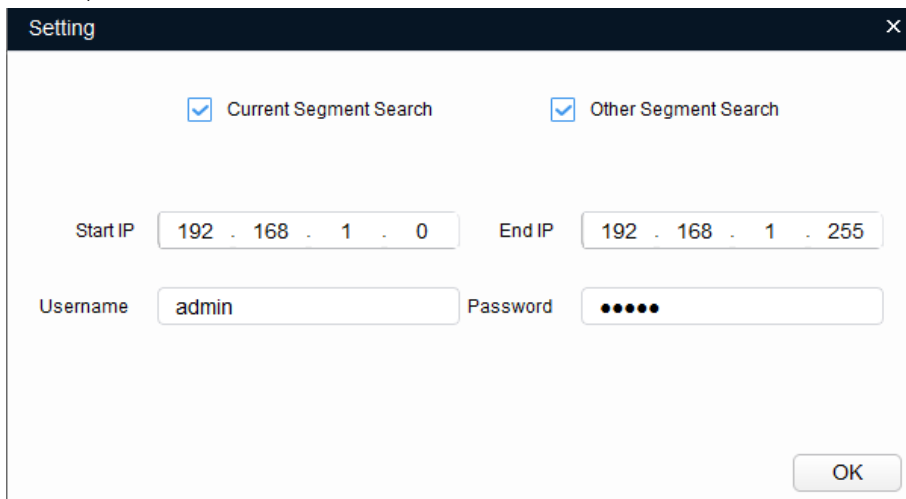

Figure 5-6

- Current Segment Search: select it, search device in the same segment with PC.
- Other segment search: select it, search device by start IP and end IP.



# 6 Web Operation

## 6.1 Intro to WEB

**Note:**

**Different devices and different versions of WEB may have different interface, please subject to actual models.**

### 6.1.1 First Time Login

Please follow the steps listed below for network connection.

Step 1. Make sure the HD intelligent traffic camera has connected to the network properly.

1. Connect Ethernet cable into PC port, and connect the other end of cable to device port.
2. Set PC IP address and device IP address to be in the same segment.  
Network segment is 192.168.1.X, but do not set to 192.168.1.108.
3. Ping `***.***.***.***` (device IP address) command on PC, check network.

Step 2. Set separate IP address, subnet mask and gateway for host and device.

Step 1. If there is no router device in the network, please allocate IP address in the same segment.

Step 2. If there is router device, then please set corresponding gateway and subnet mask.

Step 3. In IE enter device IP address, click Enter, log in WEB.

Step 4. In pop-up login interface, enter username and password. Default username and password are both admin, click Login.

**Note:**

**For device to be initialized, please initialize it first before usage.**



Figure 6-1

Step 5. After you have logged in for the first time, enter config wizard to change your password.

**Warning:**

**For security reason, please change initial password.**

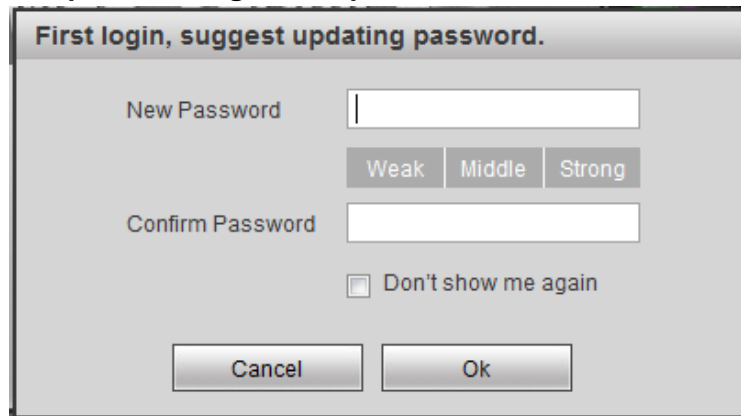

Figure 6-2

Step 6. Modify password and click Next, you can enter WEB homepage.

**Note:**

- If this is the first time you log in WEB, please install plug in following instructions.
- Before you installing plug-in, please go to Internet Options>Security, and enter active related plug-in or enable prompt.

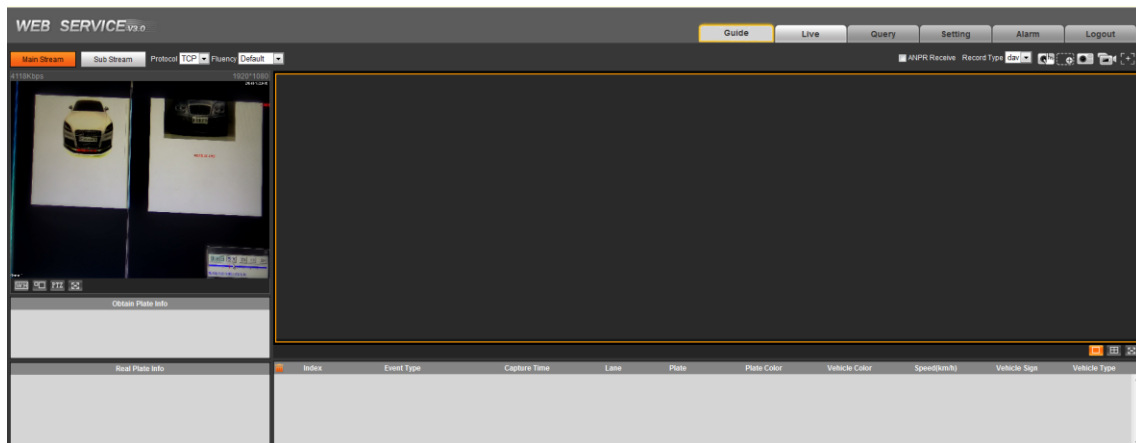

Figure 6-3

**Note:**

When you leave no operation on WEB for a long time, you will see failed authentication box, and must log in again.

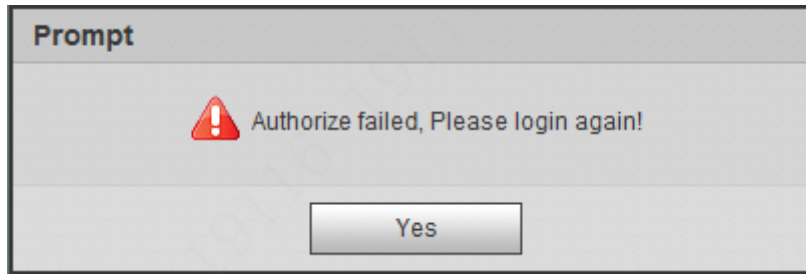

Figure 6-4

### 6.1.2 Non-First Time Login

Step 1. In IE enter device IP address, click Enter.

Step 2. Enter username and password, click Login.

When you enter wrong username or password, you can see Figure 6-5. If you have enter wrong username or password for 5 consecutive times, the account will be locked for 5 minutes. See Figure 6-6.

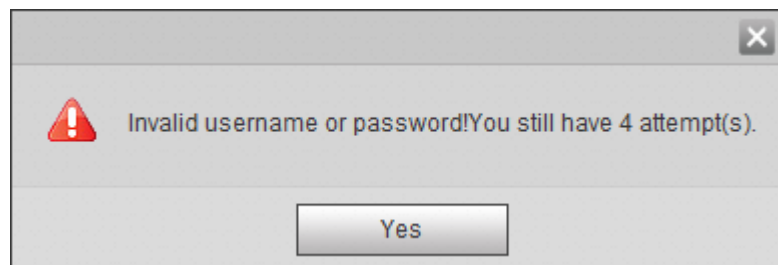

Figure 6-5

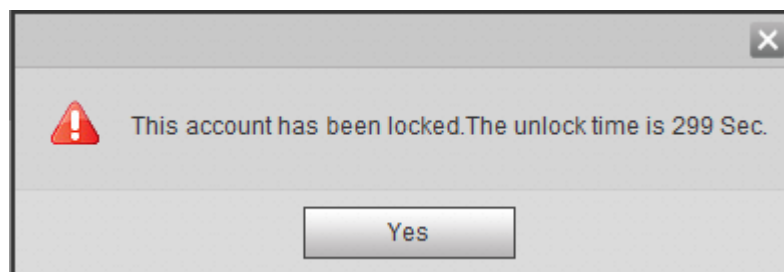

Figure 6-6

### 6.1.3 Function

Here uses DHI-ITC231-RF1A (-IR) as example.

Function	Note
Guide	Guide user to quickly understand usage of WEB.

Function	Note
Live	Introduces video and image window, record video and image setup and etc.
Playback	Introduce how to play system storage record file.
Search	Introduce different types of picture and record search, and watermark.
Setup	Introduce camera basic setup, ITC rule, protocol and etc.
Alarm	Introduce alarm prompt operation.
Logout	Introduce WEB client logout.

Chart 6-1

## 6.2 Live

After you successfully log in WEB, system shows Live interface, here you can preview video, picture and snapshot record.

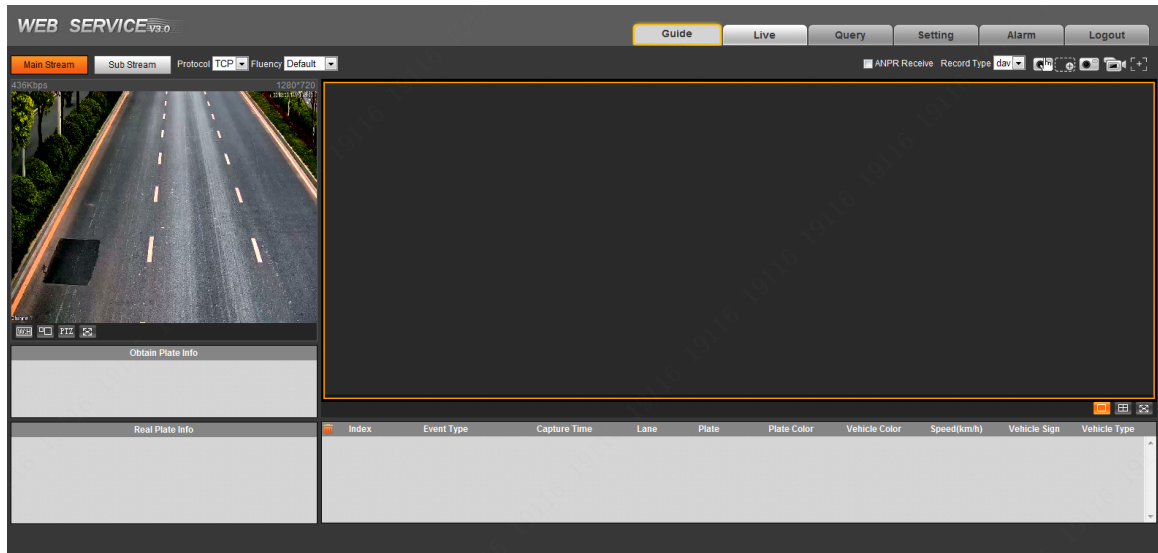

Figure 6-7

### 6.2.1 Video Bit Stream Bar

The video bit stream bar interface is shown as in Figure 6-8 Video Bit Stream Bar.

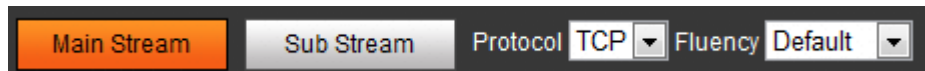

Figure 6-8 Video Bit Stream Bar

Please refer to the following sheet for detailed information.

Parameter	Function
Main stream	You can use main stream to record video record, network monitor function under normal network environment. You can set resolution within its supported range.

Extra stream	It is a substitute for main stream under insufficient band width.
Protocol	Select video monitoring protocol, currently support TCP only.
Fluency	Select video fluency.

Chart 6-2

### 6.2.2 Preview Window Switch

The preview window switch interface is shown as in Figure 6-9 Preview Window Switch.



Figure 6-9 Preview Window Switch

- ---- Aspect ratio, adjust image to original size or best fit.
- ----Window switch to large window and display adjusting window.
- ----Control lens, available for motorized focus.
- ----Full screen display.

### 6.2.3 Common Function Bar

The common function bar interface is shown as in Figure 6-10 Common Function Bar.

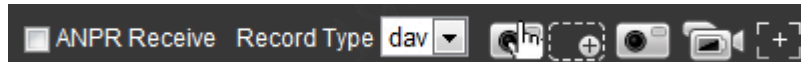

Figure 6-10 Common Function Bar

Please refer to the following sheet for detailed information.

Icon	Parameter	Function
	Receive Pictures	Check it to automatically receive pictures via snapshot, RS485, RS232, and video detect. Record plate, vehicle color, speed and other info and display them in window.
	Record Type	Select record format, default format is dav.







	Manual snapshot	Click on the button to snapshot. Snapshots are saved based on setup in "Setup->Camera->Video->Path". Note: Check Receive Pictures and then snapshot picture and vehicle info will be shown in Live interface.
	Zoom in	Click on the button to zoom in any area with left mouse. Right click mouse or click  to exit.
	Snapshot	Click on the button to snapshot current picture and save it to storage path.
	Record	Click on the button to record When video is open, saved to "Setting>Storage>Destination>Path".
	AUZ Focus	Click it, you can preview AP Peak and AF Max parameters. The closer the AF Peak value and AF Max are, the better the focus effect will be. Definition of the two parameters: <ul style="list-style-type: none"> <li>● AF Peak: this value is shown during live focus as video feature.</li> <li>● AF Max: this value is best representation of video clarity.</li> </ul>



Chart 6-3

### 6.2.4 Monitor Window Switch

The monitor window switch interface is shown as in Figure 6-11 Monitor Window Switch.



Figure 6-11 Monitor Window Switch

-  ----Display in single window.
-  ---- Display in four windows.
-  ---- Display in full screen.

## 6.3 Guide

Quickly set camera work mode, plate pixel check, trigger mode, external light config and etc.

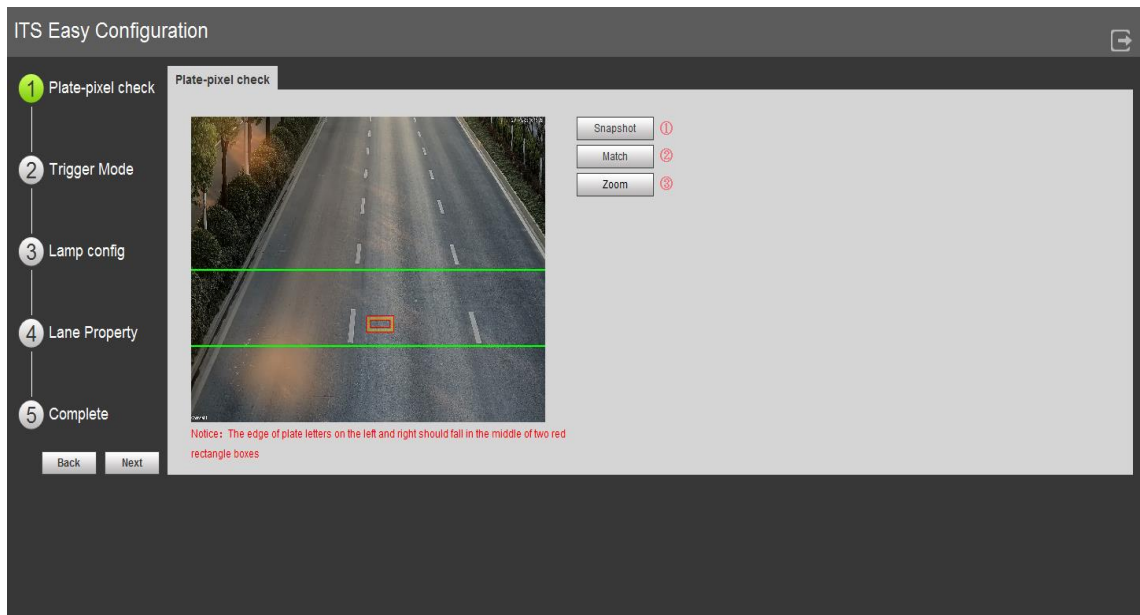

Figure 6-12

### 6.3.1 Plate-pixel Check

Check vehicle plate pixel and confirm pixel of snapshot plate.

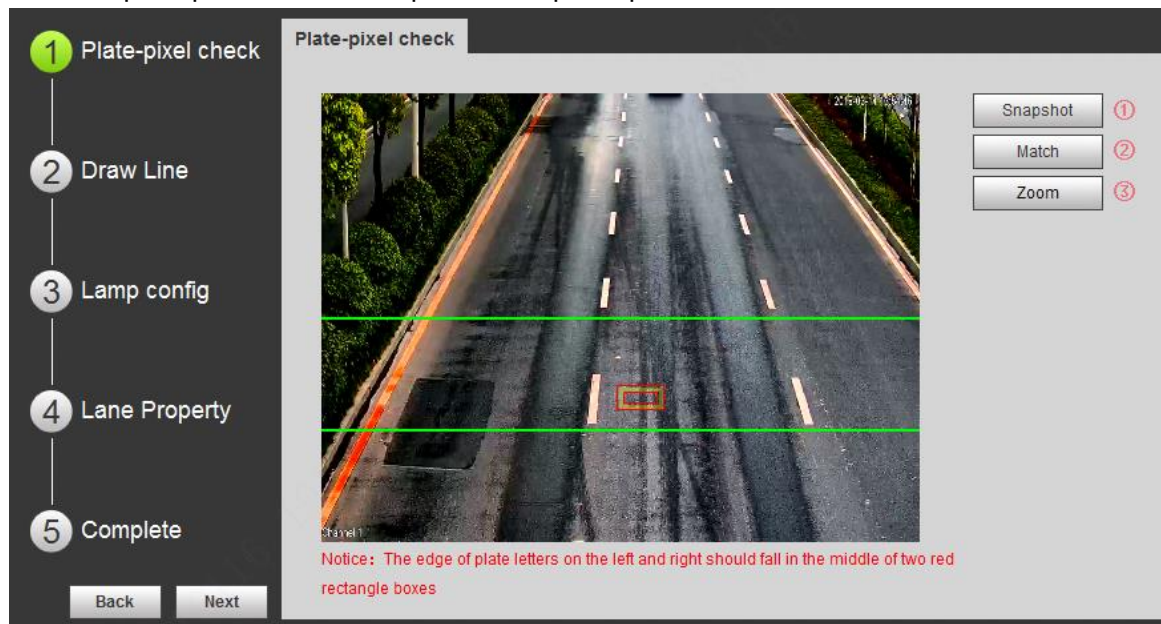

Figure 6-13

Step 1. Click "snapshot" to snapshot picture when the vehicle plate run into the green area (detection area).

Step 2. Moving the small rectangle box to cover the area of plate.

Step 3. Click “zoom” to zooming the picture, please check the size of vehicle plate is between the inner edge and outer edge of rectangle.(if size no matching, the pixel of plate must be not easy for recognize , please change the lens or the angle of camera)



Figure 6-14

### 6.3.2 Trigger Mode

Before you set trigger mode, select whether to use radar speed measurement, see Figure 6-15.



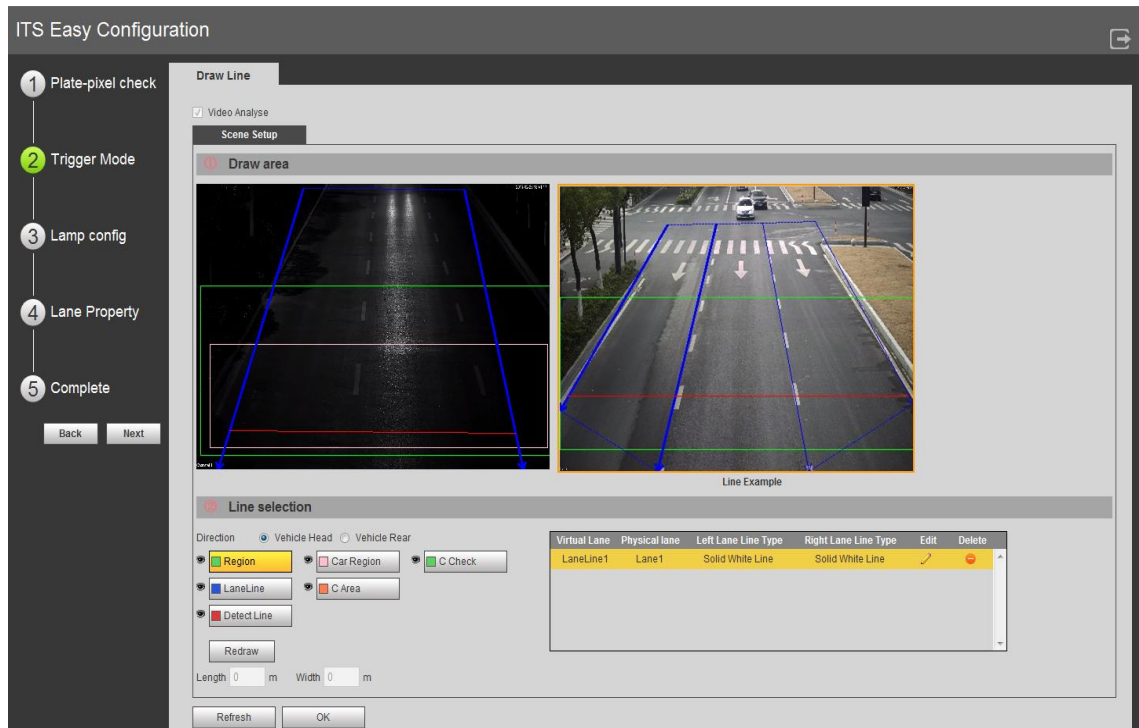

Figure 6-15

Step 1. Select config line you want to draw.

Step 2. Draw line within visible range.

Note:



- Click Redraw to delete current config line.
- In lane direction select head or rear to quickly switch lane direction.

Parameter	Note
Direction	Both indicator direction of vehicle, but algorithms are different. <ul style="list-style-type: none"> <li>● Select head, lane arrow is down.</li> <li>● Select rear, lane arrow is up.</li> </ul>
Region	Set area to be detected. Area is shown in green box.
Lane Line	According to actual traffic condition, draw lane to be detected. Each lane needs two lines. Lane arrow means direction of vehicle. Lane line is shown in blue with arrow.
Detect Line	Draw intelligent border line for snapshot which is used as loop in actual traffic. When a vehicle reaches this line, it will snapshot. Delete line is only effective within drawn lane, not outside the area. Delete line is red.
Car Region	Used to detect vehicle flow region.
C Area	Used to verify calibrated area.

Parameter	Note
C Check	Used to verify accuracy of calibration result. Click "C Check", draw line in the area and it shows actual length. Click "Redraw" to delete original line.

Chart 6-4

Step 3. After lane line is drawn, it auto shows lane info. You can modify or delete current Lane Line.

- Click  of corresponding lane to set.
- Click  to delete current lane line. After setup is complete, click OK to take effect.



Virtual Lane	Physical lane	Left Lane Line Type	Right Lane Line Type	Edit	Delete
LaneLine1	Lane1	Solid White Line	Solid White Line		

Figure 6-16

Parameter	Note
Virtual Lane	Set drawn virtual lane name.
Physical Lane	According to actual condition, set lane no.
Left Lane Line	Set lane line type, you can select white solid lane, white void line and yellow lien.
Right Lane Line	

Chart 6-5

Step 4. Click OK below to take effect.

### 6.3.3 Lamp Config

Set flash lamp, frequency lamp work mode via 485.

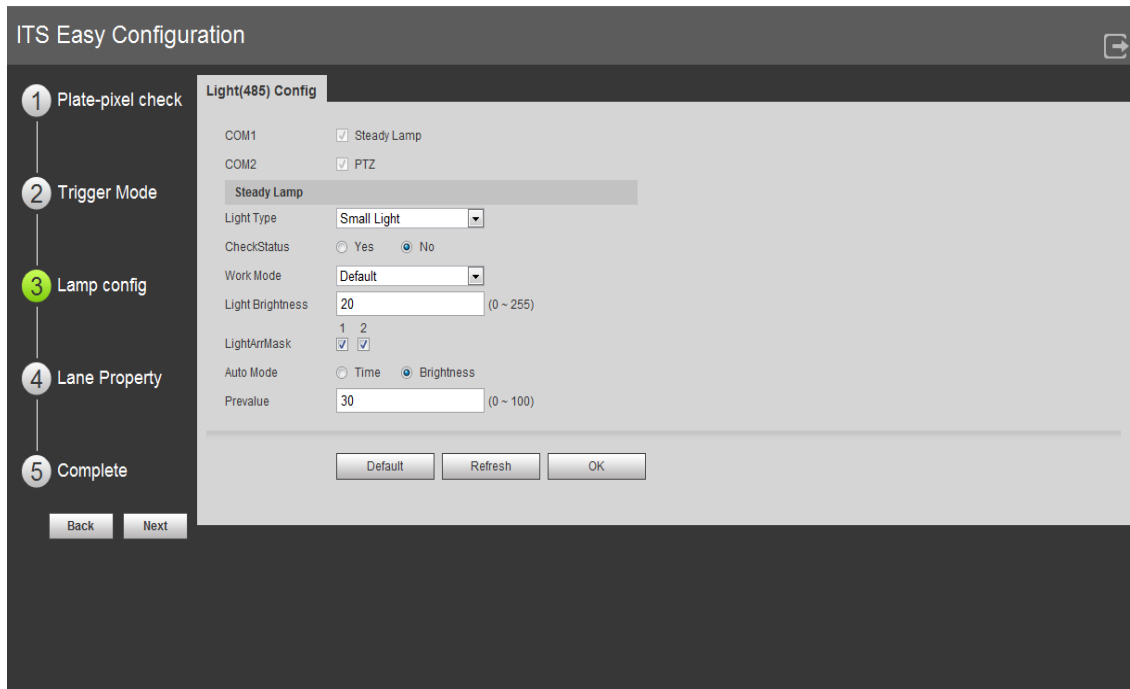

Figure 6-17

Parameter	Note
COM1, COM2	Select serial according to actually connected port A and B.
Light Type	You can select small or big light.
CheckStatus	Select to enable detection status of external light.
Work Mode	Select work mode, include: <ul style="list-style-type: none"> <li>● Turn off: NO light always off</li> <li>● Turn on: NO light always on</li> <li>● Default: According to time or brightness, auto turn on light</li> </ul>
Brightness	Set No light normal work brightness value
Light Brightness	Set light brightness
LightArrMask	Set light no. Note: valid in auto work mode only
Auto Mode	You can auto turn on/off light according to time or brightness. Time: Set NO light on period. 7 independent days in a week and 6 periods each day. Brightness: current brightness is below preset value, light ON; higher than preset value, light OFF. Note: valid in auto work mode only
Prevalue	Brightness parameter value Note: valid in auto work mode and select Brightness only.
Time Settings	Set auto brightness light time. Note: valid in auto work mode and select Time only.

Chart 6-6

### 6.3.4 Lane Property

Set lane info and configure event.

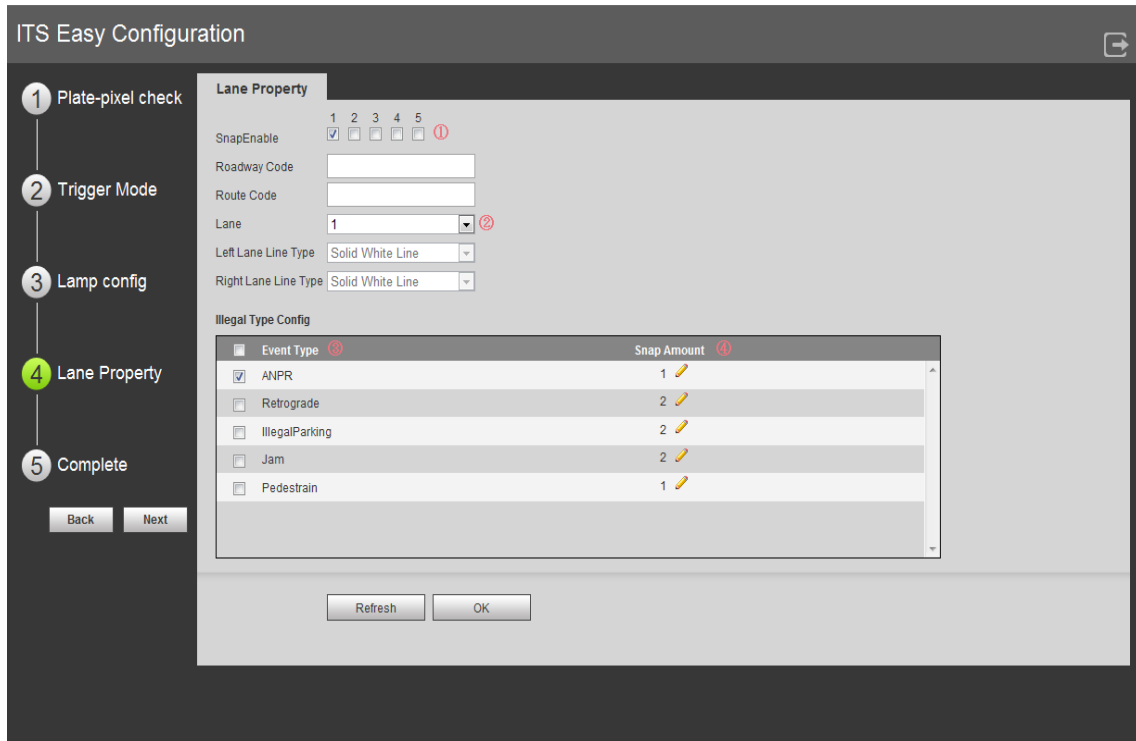

Figure 6-18

Parameter	Note
<b>Lane Property</b>	
Snap Enable	Select lane you want to enable its snapshot, here no. correspond to physical lane.
Roadway Code	Fill in roadway code.
Route Code	Fill in router code.
Lane	Select device snapshot lane.
Left Lane Line Type	Default is Solid White Line.
Right Lane Line Type	Default is Solid White Line.
<b>Event Config</b>	
<b>Note:</b>	
<b>Different lane types correspond to different event types.</b>	
ANPR	Select whether to snapshot ANPR vehicle.
Retrograde	Select whether to snapshot retrogradation vehicle.
Illegal Parking	Select to snapshot vehicle parked in authorized area.
Jam	Select whether to snapshot traffic jam event.
Pedestrian	Select whether to snapshot pedestrian.

Chart 6-7

### 6.3.5 Complete

View camera version and work mode after config.

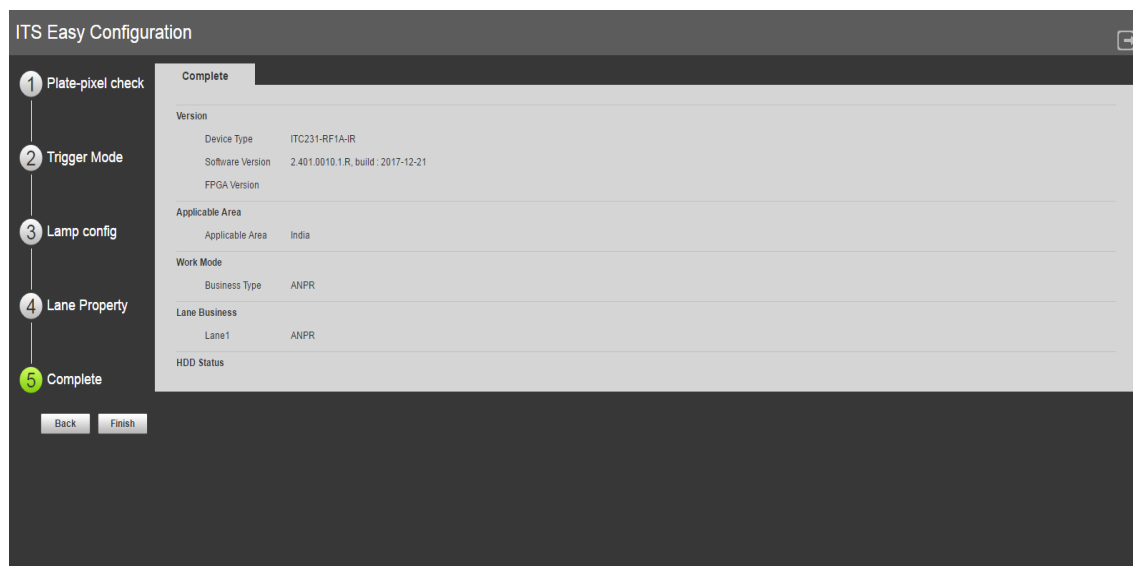

Figure 6-19

## 6.4 Query

### 6.4.1 Picture Query

#### 6.4.1.1 SD Card Picture

Click query button, you can see an interface is shown as in Figure 6-20 Picture Query.

Please select start time, end time, and event type. Then please click search button, you can see the corresponding files in the list.

Select the file(s) you want to download and then click download button, system pops up a dialogue box, then you can specify file name and path to download the file(s) to your local pc. Click Ok to complete the download procedure.

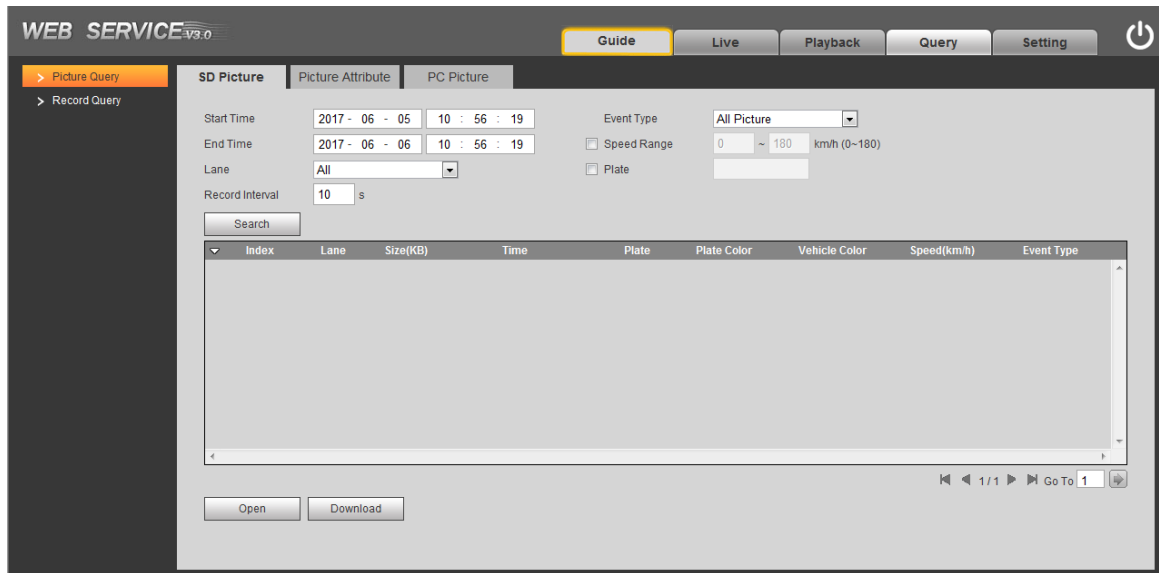

Figure 6-20 Picture Query

Please refer to the following sheet for detailed information.

Parameter	Function
Start time	Set start time of picture to search.
End time	Set end time of picture to search.
Event type	Search by violation event type.
Vehicle Sign	Select, it searches picture by logo. Note: ANPR mode only.
Lane	Select device snapshot lane.
Speed range	Search by speed range.
Plate	Search by plate.
Record Interval	Use this as filter to search picture.
	Click this button to download link record. Note: After you enable link record, violation picture will always has this icon, linked record subject to actual condition.

Chart 6-8

Step 1. Enter search picture parameter, click Search.

Searched picture files are shown in file list.

Step 2. Select the need to download images from the file list, click "Download."

Step 3. In the pop-up picture Save dialog box, set the image saving path, start the system image is downloaded to the local PC.

### 6.4.1.2 Picture Attribute

According to need of download pictures, setting qualifying picture information, click "Help ..." to see the naming rules. See Figure 6-21 Download Picture Naming.

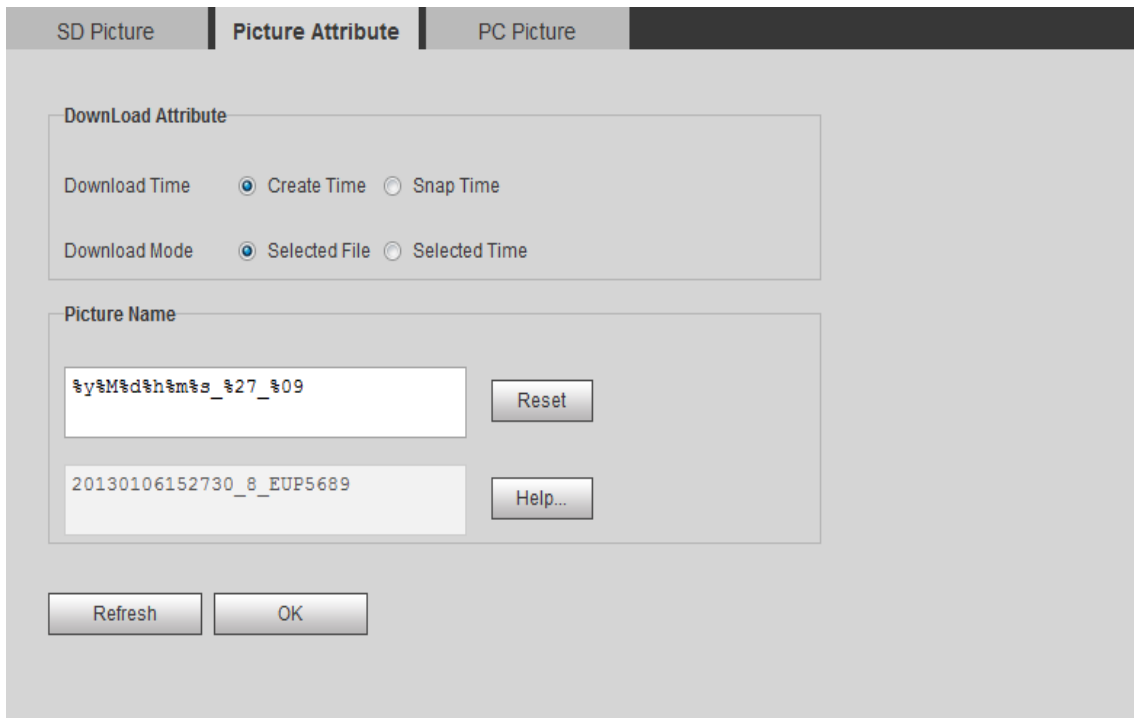

Figure 6-21 Download Picture Naming

Download	<ul style="list-style-type: none"> <li>• Create time: image downloaded to a PC, the modification time image attributes using a PC time.</li> <li>• Snap time: image downloaded to a PC, the modification time image attributes using a device snapping time.</li> </ul>
Download Mode	<ul style="list-style-type: none"> <li>• Select File: Select the desired image (which can be a radio or select multiple pictures, which is to support batch download), click "download", the Save dialog box will pop up.</li> <li>• Selected time: just click "download", the system will automatically start time to end time to download all the pictures down.</li> </ul>
Reset	<ul style="list-style-type: none"> <li>• Download picture naming back to factory default naming.</li> </ul>

Help	<ul style="list-style-type: none"> <li>• View naming rule.</li> </ul>
------	---

Chart 6-9

### 6.4.1.3 PC Picture

Click "Open local ", select the required check image, click "Watermark check" to see the check results in the pictures list.

Select the picture and click "Open" to preview the image.

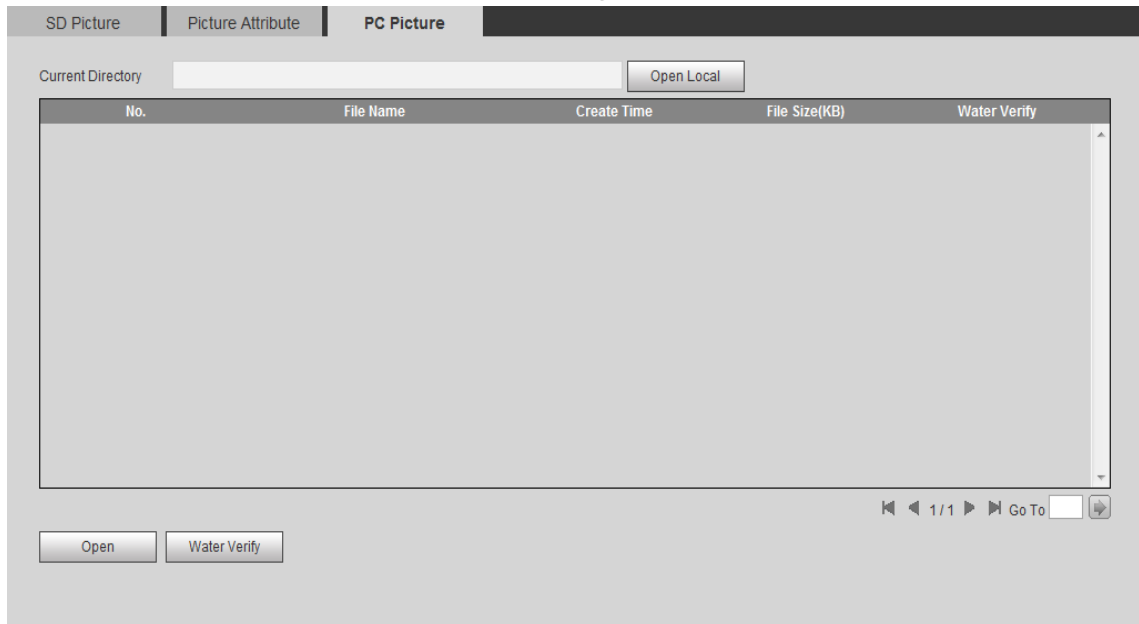

Figure 6-22 Search Local Picture

Step 1. Click Open Local, and select folder of picture.

Step 2. Select picture, click Water-Verify and you can see result in picture list.

Step 3. Select picture, click Open or double click picture to preview picture.

### 6.4.2 Flow Query

Count vehicle flow in selected area. Select "Query>Flow Query", see Figure 6-23.



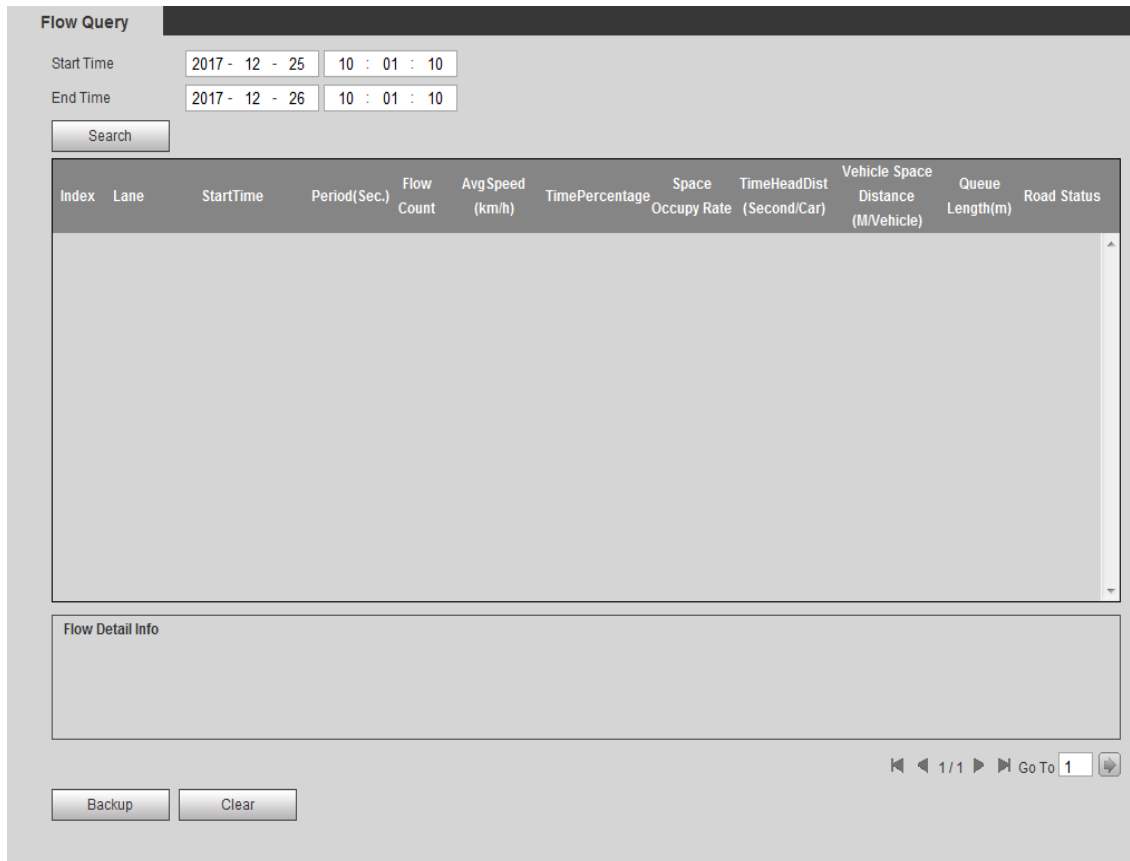

Figure 6-23

Step 1. Set start time and end time for search.

Step 2. Click Search, click Backup to back up to local PC. Click Clear to view result.

### 6.4.3 Record Query

#### 6.4.3.1 Record

Click record query, you can see an interface is shown as in Figure 6-24 Record Query.

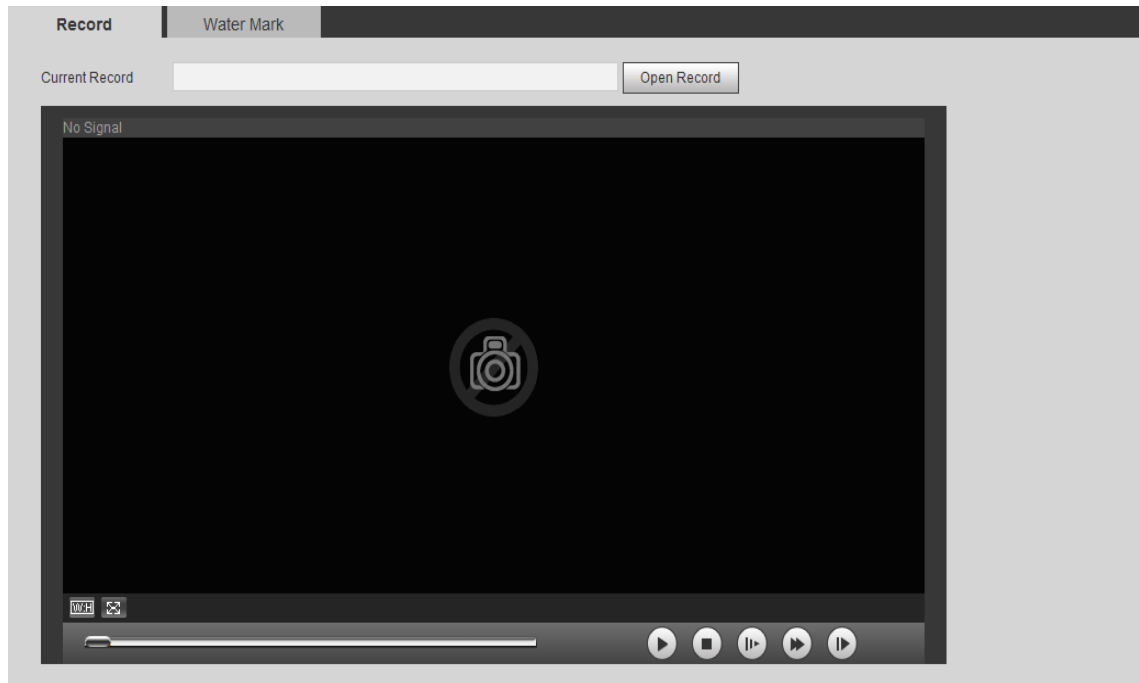

Figure 6-24 Record Query

#### 6.4.3.2 Watermark

**Note:**

Users are required to use this function in "Settings> Camera Settings> Video" section, select the watermark settings enabled, set the corresponding watermark character, the default watermarks characters: DigitalCCTV.

Select the video file, click the "Watermark check", the system displays the checksum progress, normal watermark. See Figure 6-25 Watermark.

Step 1. Click Open Record, select record file.

Step 2. Click Water Verify, system shows progress and normal water mark info.

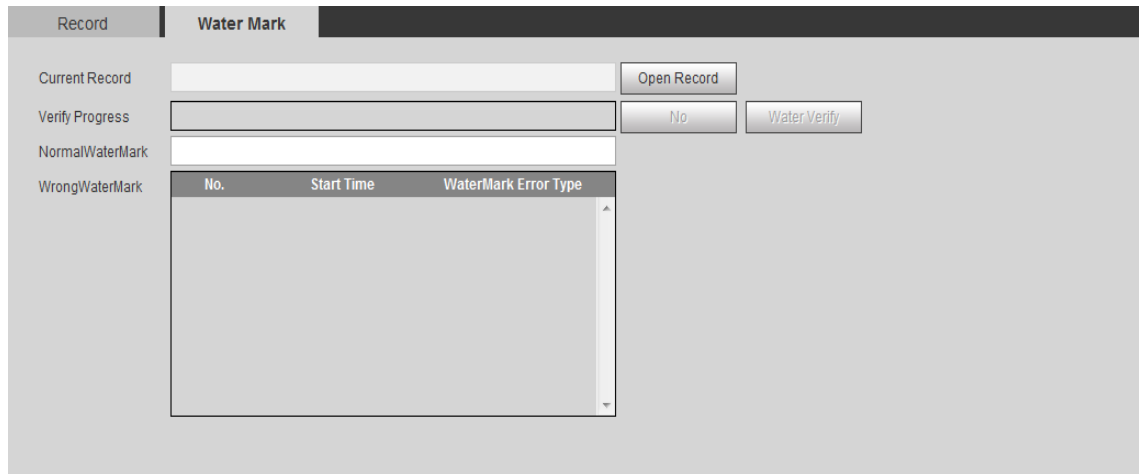

Figure 6-25 Watermark

Step 3. After completion, the page shows watermark is finished.

## 6.5 Configure

### 6.5.1 ITC

#### 6.5.1.1 Lane Property

User shall set related parameter according to their need.

ANPR device need different config of event.

Select Setting>ITC>Lane Property, see Figure 6-26.

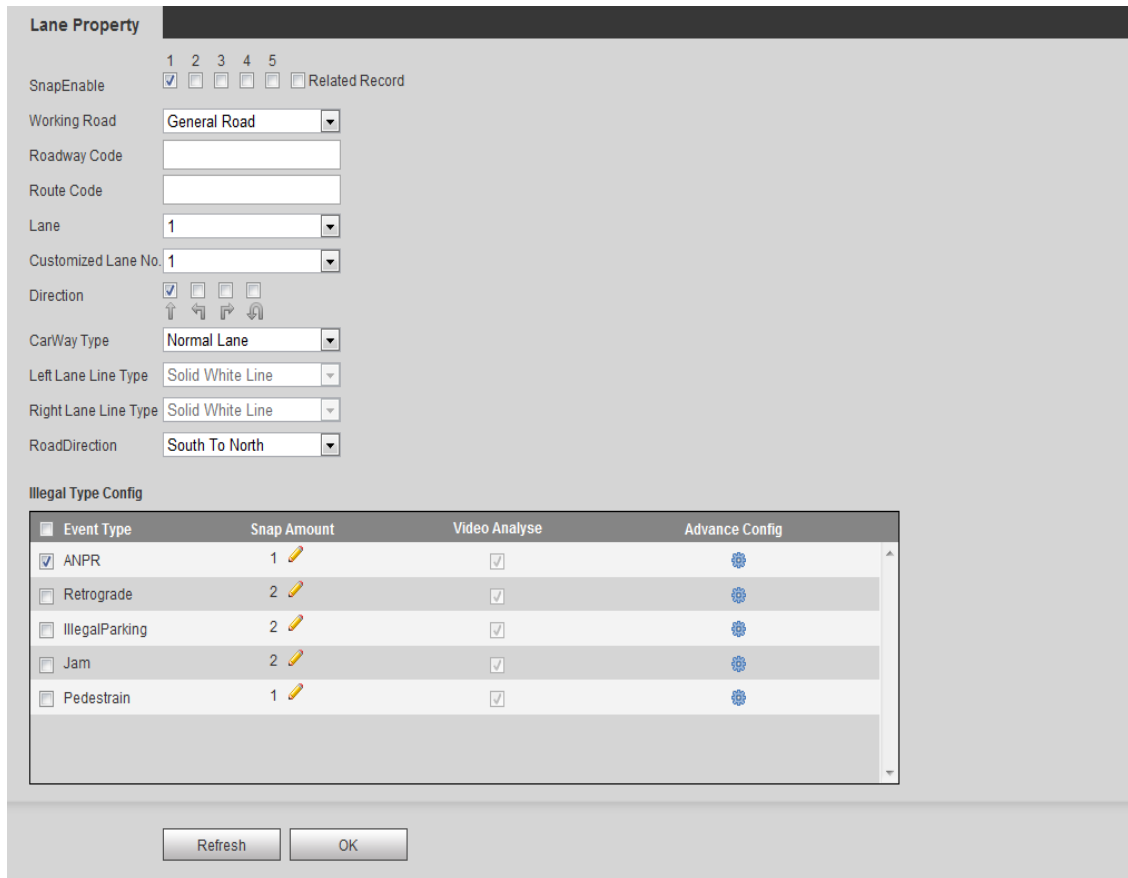



Figure 6-26

Please refer to the following sheet for detailed information.

Parameter	Function
Lane Property	
Enable snapshot	Select lane to enable. The no. corresponds to actual lane no.
Related Record	Check the "related record", the time will be illegal to capture video, set the length of recording time as shown in figure.
Working road	Select road type.
Roadway Code	Fill in according to actual condition.
Route Code	Fill in according to actual condition.
Lane	Select lane to snapshot.

Customized lane no.	Set different no. for each lane.
Direction	Select lane direction to snapshot.
Car Way Type	Default is general lane.
Road Direction	Set lane direction.
Event Note: Different lane types correspond to different event type.	
ANPR	Select snapshot ANPR vehicle.
Retrograde	Choose whether to capture retrograde vehicles.
Illegal Parking	Choose whether to capture stops at traffic ban driveway or sidewalk parking spaces finest vehicles.
Jam	Snapshot traffic jam or not.
Pedestrian	Snapshot pedestrian or not.

Chart 6-10

Click  and see Advance Config in Illegal Type Config, and you can see Advance Config interface. Different events correspond to different advance config, the following are some examples.

The screenshot shows a dialog box titled "Advance Config" with a close button (X) in the top right corner. The dialog contains the following fields and values:

- Event Type: IllegalParking
- Trigger Time(s): 90 s (10~21600)
- Parking Time(s): 100 s (10~21600)
- Illegal Name: IllegalParking
- Illegal Code: 10391
- Record TotalTime: 5 s
- Record PreTime: 0 s

Below the fields is a button labeled "Time Settings". At the bottom of the dialog are two buttons: "No" and "Yes".

Figure 6-27

Parameter	Note
Trigger Time (s)	Set illegal parking time to trigger this event. When a vehicle illegally parks over this time, it will trigger snapshot.
Parking Time (s)	Set time length of vehicle illegal parking snapshot.
Illegal Name	Fill in violation name.
Illegal Code	Set corresponding code of violation type.
Record Total Time (s)	Set total record time of violation snapshot. Time range is 5s~20s.
Record Pre Time (s)	Set snapshot prerecord time length. Time range is 0s~5s. Note: Total time of record is 3s longer than pre-record time before snapshot.
Time Settings	Set enabled time of snapshot. 7 independent days in a week, 6 periods each day.

Chart 6-11

Click Time Settings, see Figure 6-28.

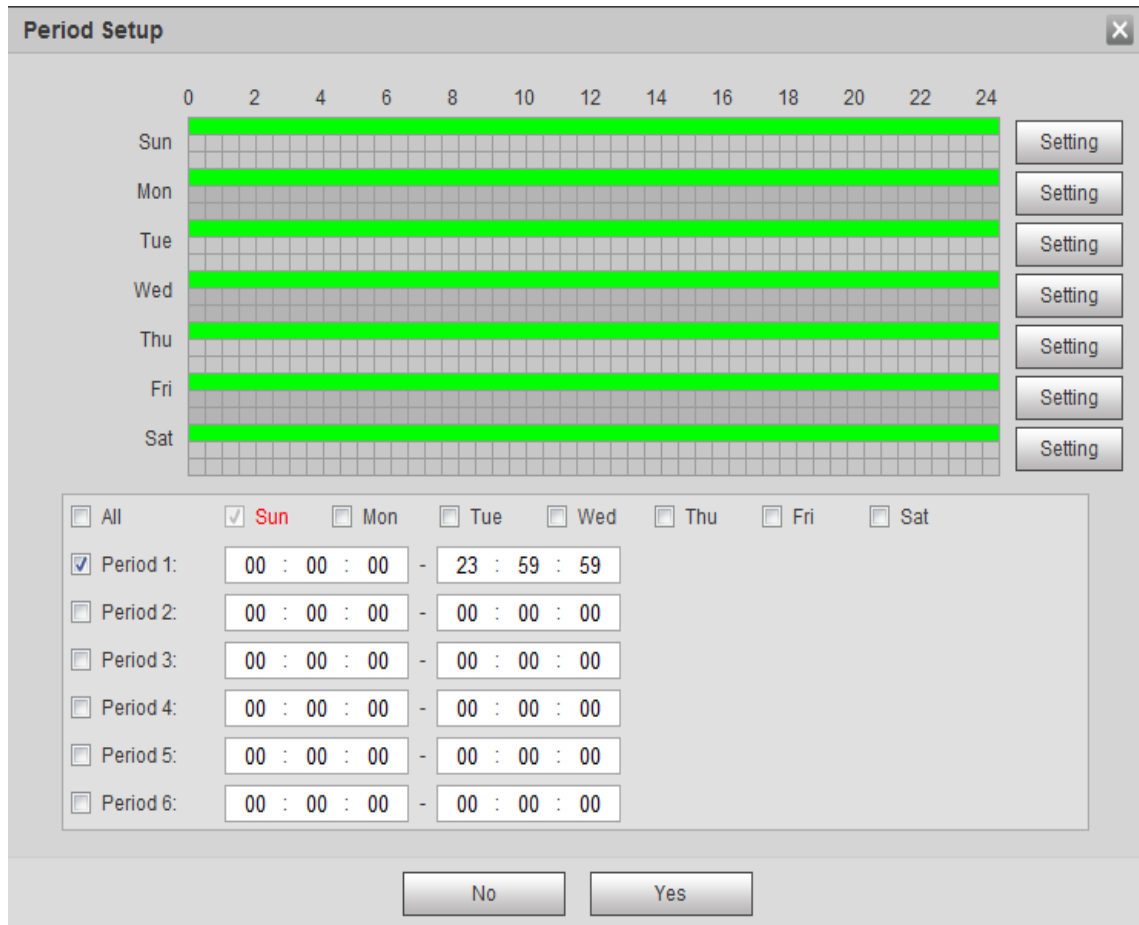

Figure 6-28

To set time period:

Step 1. Select week day or click Setting.

Step 2. Select period no. to enable, and manually enter start time.

Step 3. Click Yes.

### 6.5.1.2 Snapshot

Set max speed, match method and location mode of snapshot.

The snapshot interface is shown as in Figure 6-29 Snapshot.

Figure 6-29 Snapshot

Please refer to the following sheet for detailed information.

Parameter	Note
Max Speed	When it detects vehicle speed over this value, system will auto fix vehicle speed to random value within normal speed range.
Snap Position Mode	Set camera snapshot location, either fixed or auto mode.

Chart 6-12

### 6.5.1.3 Intelligent

ANPR mode supports analysis of scene config, speed measure config, recognition config and advance config.

#### 6.5.1.3.1 Video Analysis-Scene Setup

Draw area line, lane line and detection time in s scene, and set.

Step 1. Select Setting>ITC>Intelligent>Video Analyse>Scene Setup. See Figure 6-30 Video Analysis-ANPR.



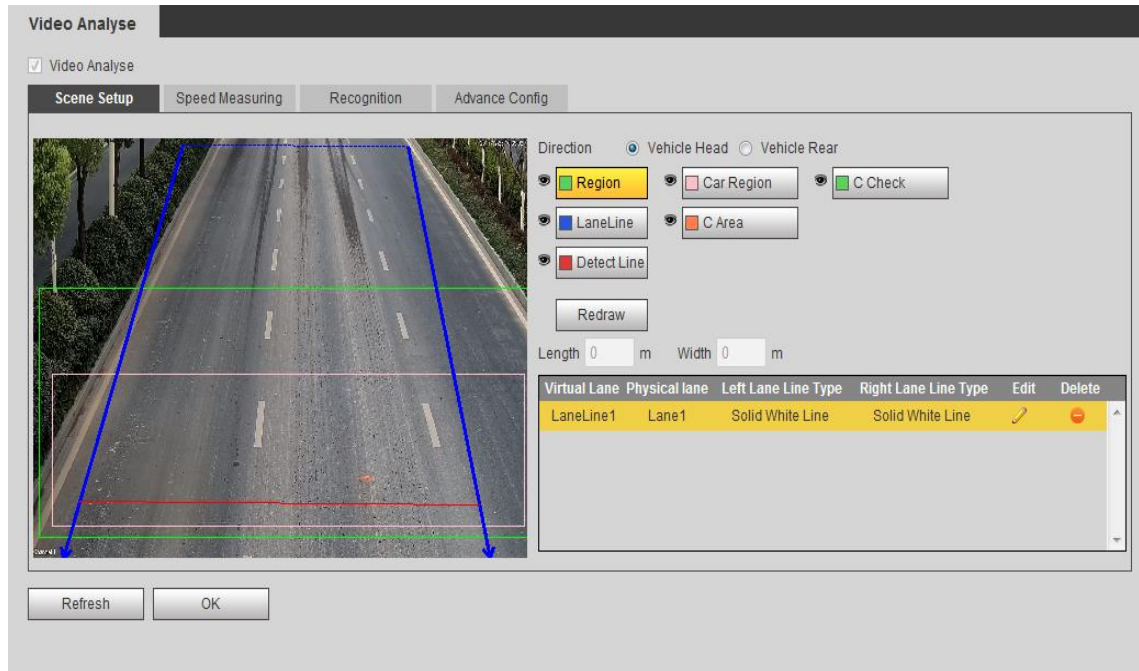

Figure 6-30 Video Analysis-ANPR

Step 2. Select line you want to draw.

Step 3. In video, draw out the line.

Note:

- Click Redraw to delete current config line.
- In lane direction, select head or rear to quickly switch lane line direction.



Please refer to the following sheet for log parameter information.

Parameter	Function
Direction	Means direction of moving, in two algorithm. <ul style="list-style-type: none"> <li>● Select Vehicle Head: lane line downward.</li> <li>● Select Vehicle Rear, lane line upward.</li> </ul>
Region	Set detect region. Select and click on redraw to drawn region as green box in Figure 4-8.
Lane line	<ul style="list-style-type: none"> <li>● Draw lane according to actual condition.</li> <li>● Each lane requires two lines.</li> <li>● Arrow of lane represents moving direction.</li> <li>● Select and click on redraw to drawn region as blue box in Figure 4-8.</li> <li>● You can only draw in up/down direction.</li> </ul>

Detect line	<ul style="list-style-type: none"> <li>• Draw border line to trigger snapshot which is similar to actual coil. When vehicle reach this line, snapshot will be triggered.</li> <li>• Detect line is available inside drawn region only.</li> <li>• Select and click on redraw to drawn region as red box in Figure 4-8.</li> </ul>
Front/Rear	When you select front, lane arrow is downward. When you select rear, lane arrow is upward. These are vehicle moving direction with different representations.
Car Region	Used to detect vehicle flow region.
C Area	Used to verify calibrated area.
C Check	Used to verify accuracy of calibration result. Click "C Check", draw line in the area and it shows actual length. Click "Redraw" to delete original line.

Chart 6-13

Step 4. After lane line is drawn, it auto shows lane info.

- Click  corresponding lane to set.
- Click  to delete current lane line. Click Yes you are done.



Virtual Lane	Physical lane	Left Lane Line Type	Right Lane Line Type	Edit	Delete
LaneLine1	Lane1	Solid White Line	Solid White Line		

Figure 6-31

Parameter	Note
Virtual Lane	Set drawn virtual lane name.
Physical Lane	According to actual condition, set lane no.
Left Lane Line	Set lane line type, you can select white solid lane, white void line and yellow lien.
Right Lane Line	

Chart 6-14

Step 5. Click OK to set.

### 6.5.1.3.2 Video Analysis-Light Group

By setting camera installation position, you can measure video speed.

Select Setting>ITC>Intelligent>Video Analysis>Speed Measuring. After setup is complete, click OK.

See Figure 6-32 Light Group and Chart 6-15.

#### Warning:

**Setup value must match actual value, otherwise video speed measurement will be inaccurate.**



Figure 6-32 Light Group

Click on setup enter light group config interface to set parameter.

Please refer to the following sheet for log parameter information.

Parameter	Note
Camera height from the ground H	Actual height from camera to the ground
Distance camera & scene bottom L1	Distance from lower border to L pole.
Distance camera & scene middle L2	Distance from middle line to L pole.

Chart 6-15

### 6.5.1.3.3 Video Analysis-Recognition

By setting recognition, set snapshot of non-plate vehicle, recognition of plate vehicle location.

Select Setting>ITC>Intelligent>Video Analyse>Recognition, see Figure 6-33 Recognition. After setup is complete, click OK.

**Note:**

**Different models of product and work mode support different recognition contents, please subject to actual interface.**

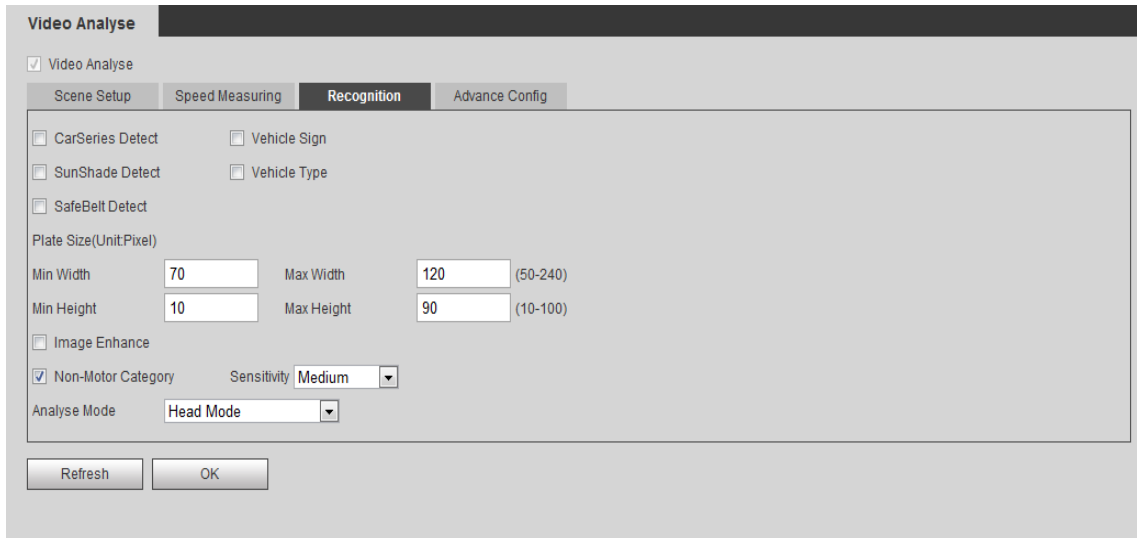

Figure 6-33 Recognition

Please refer to the following sheet for log parameter information.

Parameter	Function
Car Series Detect	Recognize vehicle series of different brands.
Vehicle Sign	Recognize vehicle brand.
Sun Shade Detect	Recognize if driver uses sun shade.
Vehicle Type	<ul style="list-style-type: none"> <li>Choose the parameter, you can identify the vehicle type.</li> </ul>
Safe Belt Detect	Recognize if driver wear seat belt
Plate (Unit: Pixel)	Set min width, max width, min height, and max height of plate. Only min width and max width are valid.
Non-motor category	<ul style="list-style-type: none"> <li>Select this argument, capture non-motorized vehicles and pedestrians.</li> </ul>
Sensitivity	<ul style="list-style-type: none"> <li>Set to detect device sensitivity</li> </ul>
Analyse	<ul style="list-style-type: none"> <li>Select plate mode:Head mode, tail mode, head prior mode and tail prior mode.</li> </ul>

Chart 6-16

#### 6.5.1.3.4 Video Analysis-Advance Config

Via advance config, you can set more functions.

Select Setting>ITC>Intelligent>Video Analyse>Advance Config, see Figure 6-34 Advance Config.

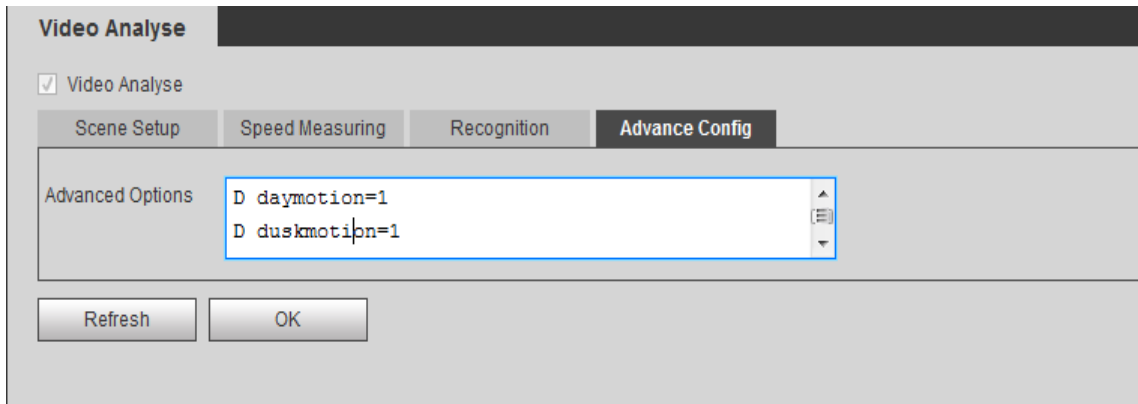

Figure 6-34 Advance Config

Please refer to the following sheet for log parameter information.

Parameter	Note
Advanced Options	You can enter a custom algorithm expression, implement special features custom.

Chart 6-17

### 6.5.1.4 OSD Config

#### 6.5.1.4.1 Video OSD

Set video channel OSD. See Figure 6-35 Video OSD.

Step 1. Select Setting>ITC>OSD Config>Video OSD.

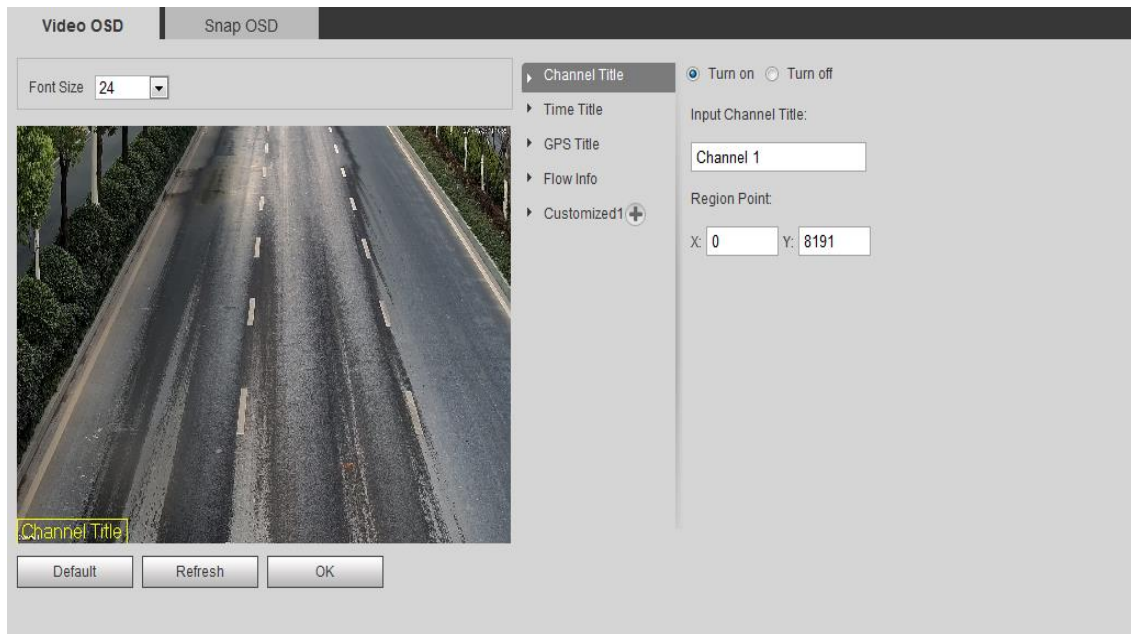

Figure 6-35 Video OSD

Step 2. Select Front Size.

Step 3. Set time title and position.

- a) Select channel title.
- b) Select Turn on.
- c) In Input Channel Title, enter channel name.
- d) Use mouse to drag yellow box or enter coordinate directly, set channel title position.

Set time title and position. ‘

- a) Click Time Title.
- b) Check Turn on.
- c) Check week display.
- d) Use the mouse to drag the yellow box or change the regional point coordinates, select the time the title of the position.

Set GPS title and position.

- a) Click GPS Title.
- b) Select Turn on.
- c) Use the mouse to drag the yellow box or change the regional point coordinates, select the time the title of the position.

Set flow info.

- a) Click Flow Info.
- b) Select Turn on.
- d) Sele Use the mouse to drag the yellow box or change the regional point coordinates, set flow info position.

You can click  to add customized region, define OSD info.

The system supports up to 6 customized regions.

Click OK.

#### **6.5.1.4.2 Snap OSD**

Set snap OSD information and location, OSD options include time, driveways name, week, location, speed, license plate, illegal code and other information. See Figure 6-36.

Step 1. Select Setting>ITC>OSD Config>Snap OSD.

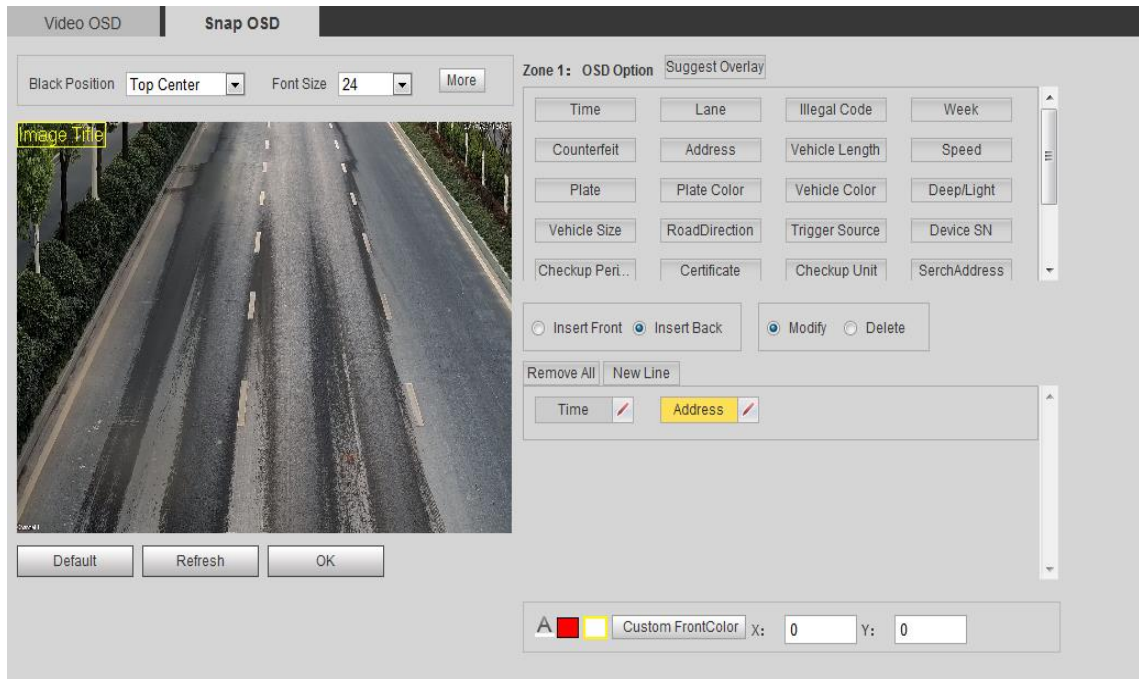

Figure 6-36 Snap OSD

Step 2. Select any position in the video and drag mouse, you can add picture title. Move box to place you want to show the title, or enter coordinate below to position the box.

You can enter up to 8 picture title, and each title has OSD option.

Note:

Select one picture title, right-click, you can delete the picture caption.

Step 3. Select OSD black border position, including up, down and none.

Step 4. Set OSD info font and font plan. You can set OSD font color below.

Step 5. Click More, a box pops up, see Figure 6-37. You can select auto change, and set OSD isolator.

Select Customized, and you can enter other isolator.

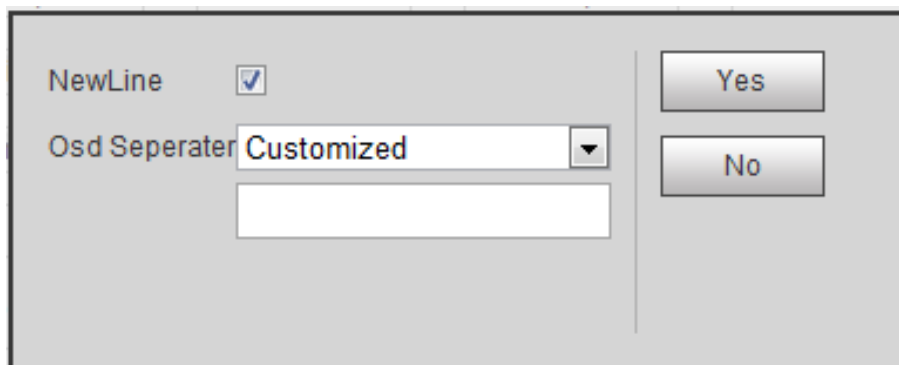





Figure 6-37

Step 6. Set OSD option.

Tips:

Click Suggest Overlay to quickly set common overlay format.

Parameter	Note
Insert Front	OSD option to adjust the order selected between.
Insert Back	OSD option to adjust the order selected between.
Modify	All selected OSD information state by  turns  , you can modify any OSD options prefix, suffix, and other content, and the number of separators.
Delete	All selected OSD information state by  turns  , you can delete any OSD options.
Remove All	Clear all selected OSD information.
New Line	OSD information will be displayed on the picture branches.

Step 7. Click OK.

### 6.5.1.5 Snap Cutout

#### 6.5.1.5.1 Snap Cutout

Check the "snap cutout enable" and click "OK", the system will recognize the license plate, the main driver face, copilot face image cutout a picture stored in the storage path.

Note:

- If you need to master the copilot human face matting, you need to open the corresponding face overlay feature to take effect.

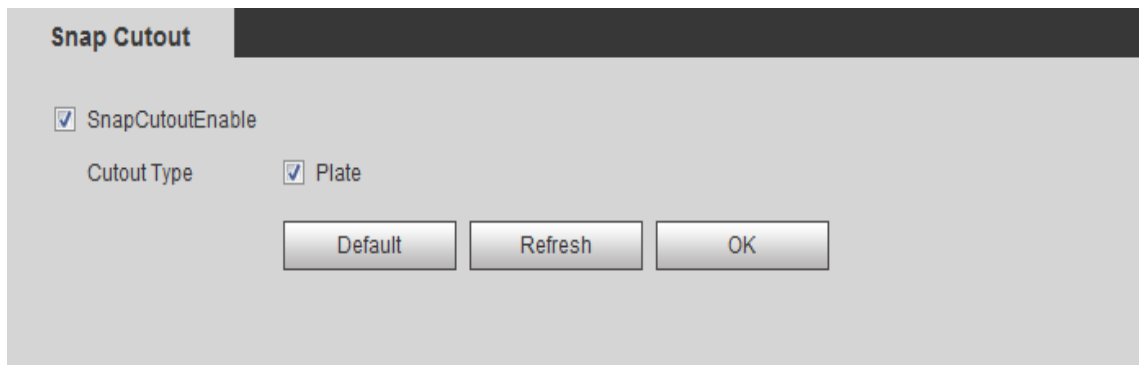

Figure 6-38 ANPR

### 6.5.1.6 Extra Device

#### 6.5.1.6.1 Extra Device Status



Select Setting>ITC>Extra Device>Extra Device Status,

The extra device interface is shown as in Figure 6-39 Extra Device. Here you can view aux device type, no. and status.

No.	Device Type	Device Number	Device Status	Match Status
1	GPS	-	! Device Unconnected	-

Refresh

Figure 6-39 Extra Device

#### 6.5.1.6.2 Light (485) Config

Set steady lamp, frequency lamp work mode via 485.

Select Setting>ITC>Extra Device>Light 9485) Config.

Extra Device Status | **Light(485) Config**

COM1  Steady Lamp

COM2  PTZ

**Steady Lamp**

Light Type

CheckStatus  Yes  No

Work Mode

Light Brightness  (0 ~ 255)

LightArrMask  1  2

Auto Mode  Time  Brightness

Prevalue  (0 ~ 100)

Figure 6-40

Parameter	Note
COM 1, COM 2	According to actual connected port A, B and select serial.
Light Type	Select small or big lamp
Work Mode	Select work mode, include: <ul style="list-style-type: none"> <li>● Forbidden: NO always OFF.</li> <li>● Always: NO always ON.</li> <li>● Default: According to time or brightness, auto turn ON or OFF.</li> </ul>
Check Status	Select to check status of light.
Light Brightness	Set NO light normal working brightness.
Light ArrMask	Set light no. Note: Auto work mode only.
Auto Mode	According to time or brightness auto turn on/off light. <ul style="list-style-type: none"> <li>● Time: Set NO period, independent config 7 days a week with 6 periods per day.</li> <li>● Brightness: When current brightness is below preset value, enable NO light. When current brightness is higher than preset value, disable NO light.</li> </ul> Note: Auto work mode only.

Parameter	Note
Prevalue	Brightness Value. Note: Auto work mode only, and Brightness is selected.
Time Settings	Auto light on time. Note: Auto work mode only, and Time is selected.

Chart 6-18

### 6.5.1.7 BW List

#### 6.5.1.7.1 White List

Select Setup>ITC>BW List.

- Enable white list, when system detects vehicle in the white list, barrier is off.
- Set white list match mode.

Figure 6-41

Parameter	Note
Start Match	When checked, set the number of matching characters and the minimum matching digits. The system will match the license plate as the white list vehicle without matching each character with the license plate number which already exists in the white list data.
Card Word	The checked characters are matched, and unselected characters will not be analyzed.
Min Word	When the number of matched characters meets the value, it is regarded as white list vehicle regardless of whether other characters match or not.

Chart 6-19

#### 6.5.1.7.2 White List Search

Search whether a plate of vehicle exists in white list.

View vehicle details.

Import/Export white list vehicle info.

White List Setup | White List Search | Black List Search

Enter Plate No.  Search

Import WhiteList  Browse... Import

No.	Plate Number	Vehicle Size	Modify	Delete
-----	--------------	--------------	--------	--------

Vehicle Detailed Information

Export Add Clear All

1 / 1 Go To

Figure 6-42

Functions:

- Search plate no.
- Edit plate info
- Delete single plate no.
- Batch delete plate no.

For example, the system import data, see Chart 6-20.

Start Time	End Time	Master of Car	Plate Color	Plate Number	Plate Type	Vehicle Color	Vehicle Size
2015/3/12 0:00	2015/9/12 23:59	A	1	A11111	1	A	1
2015/9/12 0:00	2016/3/12 23:59	B	2	A22222	2	E	2
2016/3/12 0:00	2016/3/13 23:59	C	3	A33333	3	G	2

Chart 6-20

Note:

Plate color, plate type, vehicle color and vehicle size info is entered via code above corresponding to dropdown list.

- Progressively import white list info  
Steps:  
Step 1. Click Add. See Figure 6-43.

The image shows a software dialog box titled "Add" with a close button (X) in the top right corner. The dialog is divided into two main sections: "Filter Condition" and "Detail Info".

**Filter Condition:**

- Plate Number: A text input field.
- Start Time: A date picker showing "2017 - 06 - 07".
- End Time: A date picker showing "2017 - 06 - 07".

**Detail Info:**

- Plate Color: A dropdown menu with "Yellow Background Bla" selected.
- Vehicle Size: A dropdown menu with "Large Car" selected.
- Master of Car: A text input field.
- Plate Type: A dropdown menu with "War Car" selected.
- Vehicle Color: A dropdown menu with "White" selected.

Below the "Detail Info" section is a checkbox labeled "Continue Adding", which is currently unchecked.

At the bottom of the dialog are two buttons: "No" and "Yes".

Figure 6-43

- Step 2. Enter complete plate character.
  - Step 3. Set start time and end time of its existence in white list. Once exceeding this period, the plate will no longer be in white list.
  - Step 4. Enter vehicle owner name, select whether to authorize barrier right.
  - Step 5. Check Continue Adding, click OK. Or uncheck Continue Adding, click OK.
- Batch import white list:  
Steps:  
Step 1. Progressively import white list, add the first while data on WEB.  
Step 2. Click Export, and in pop-up box click Save, select path. Click Save.

Step 3. In Export form, follow format of the first white list item, fill in other white list items you want to import, save.

Step 4. Click Brose, select path, click Import.

- Batch export white list: click Export, in pop-up box click Save. Select path and click save.

### 6.5.1.7.3 Black List Data

Select Setup>ITC>BW List>Black List Search.

Search whether a plate of vehicle exits in black list.

View vehicle details.

Import/Export black list vehicle info.

The screenshot shows a software window titled "Black List Search". At the top, there are three tabs: "White List Setup", "White List Search", and "Black List Search", with "Black List Search" being the active tab. Below the tabs, there is a section with a checkbox labeled "Enable". Underneath, there is a text input field labeled "Enter Plate No." followed by a "Search" button. Below that is another text input field labeled "Import BlackList" with "Browse..." and "Import" buttons. The main area of the window contains a table with the following columns: "No.", "Plate Number", "Vehicle Size", "Modify", and "Delete". The table is currently empty. Below the table is a section titled "Vehicle Detailed Information" which is also empty. At the bottom of the window, there are three buttons: "Export", "Add", and "Clear All". To the right of these buttons, there is a pagination control showing "1 / 1" and a "Go To" field with a dropdown arrow.

Figure 6-44

For blacklist search, import/export and white list, please see Figure 6-43.

### 6.5.1.8 Traffic Flow

#### 6.5.1.8.1 Traffic Flow

Set lane and other statistical period.

Step 1. Select Setting>ITC>Traffic Flow>Traffic Flow. See Figure 6-45.

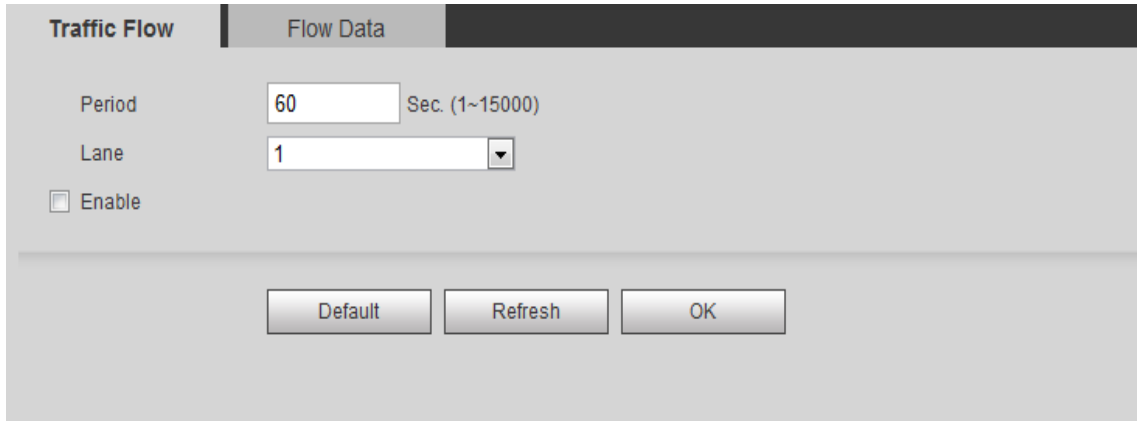

Figure 6-45

- Step 2. Set period.
- Step 3. Set flow lane.
- Step 4. Select Enable.
- Step 5. Click OK.

### 6.5.1.8.2 Flow Data

Select Setting>ITC>Traffic Flow>Flow Data, see Figure 6-46.

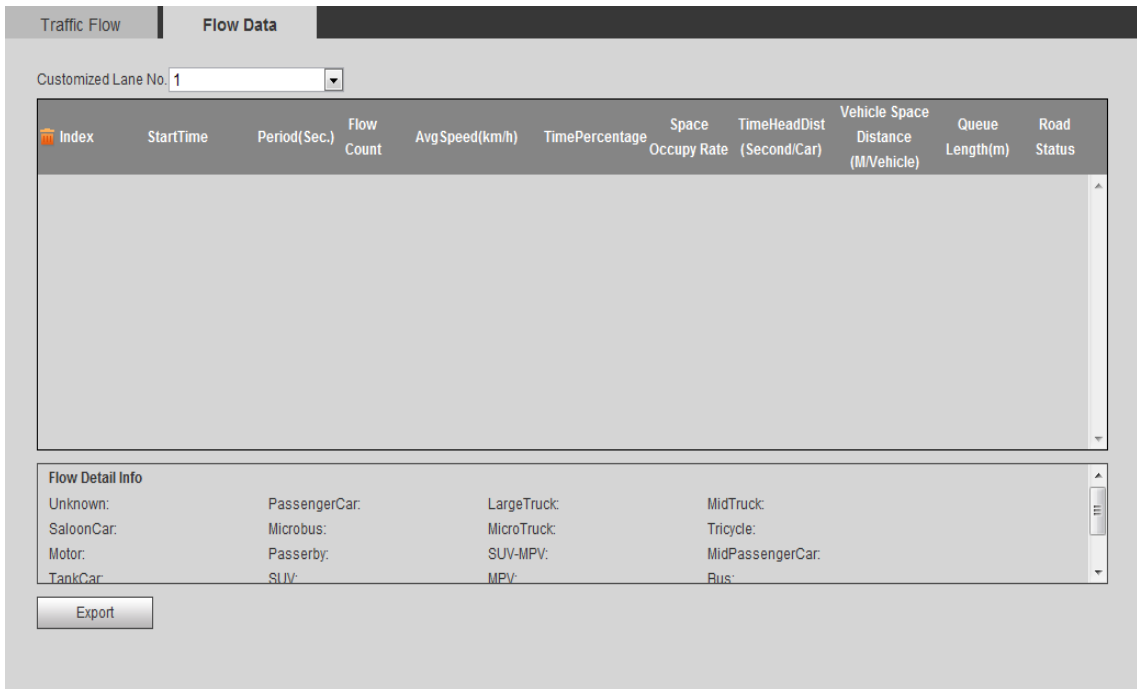



Figure 6-46

- Click a row, to view corresponding period and lane detailed info.
- Click  to delete current flow data.
- Click Export to export current flow data to local.

### 6.5.1.9 Device Direction

#### 6.5.1.9.1 Device Direction

Select Setting>ITC>Device Direction>Device Direction, see Figure 6-47.

It shows info gotten from GPS or BeiDou system.

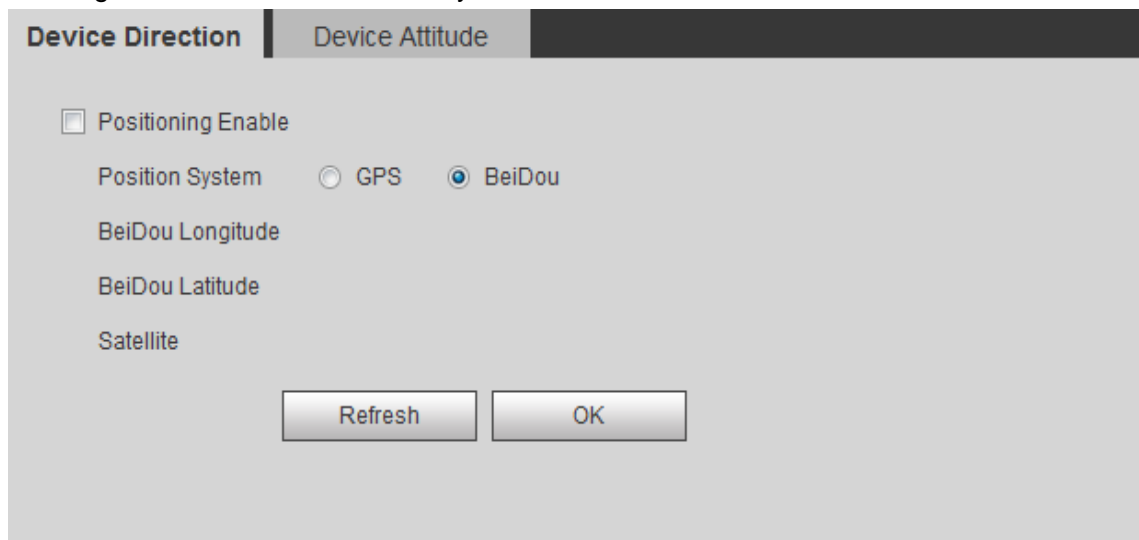

Figure 6-47

#### 6.5.1.9.2 Device Attitude

Select Setting>ITC>Device Direction>Device Attitude, enter Device Attitude interface. See Figure 6-48.



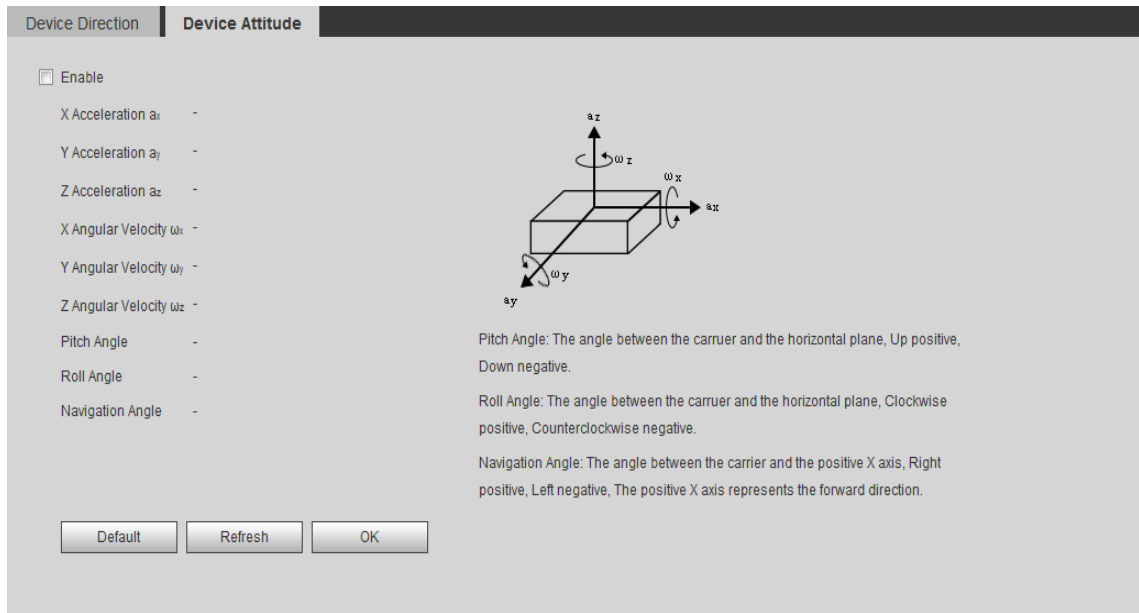

Figure 6-48

### 6.5.1.10 Intelligence Default

The intelligence default interface is shown as in Figure 6-49 Intelligence Default. Click on default to restore default settings.

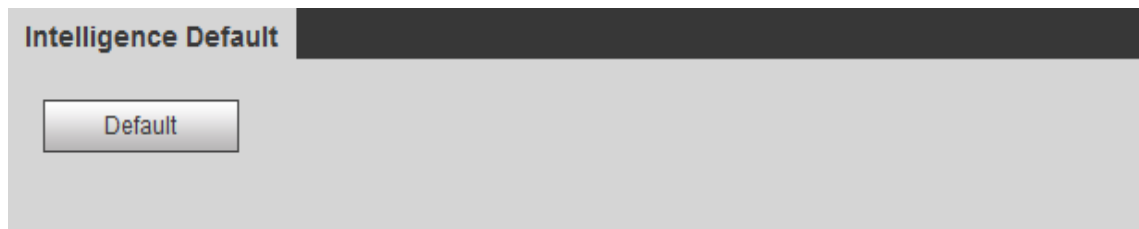

Figure 6-49 Intelligence Default

## 6.5.2 Camera

### 6.5.2.1 Attribute

#### 6.5.2.1.1 General

The general interface is shown as in Figure 6-50 General. Here you can set camera parameters. For different models, you shall refer to its parameter. Setup in this interface comes effective immediately.

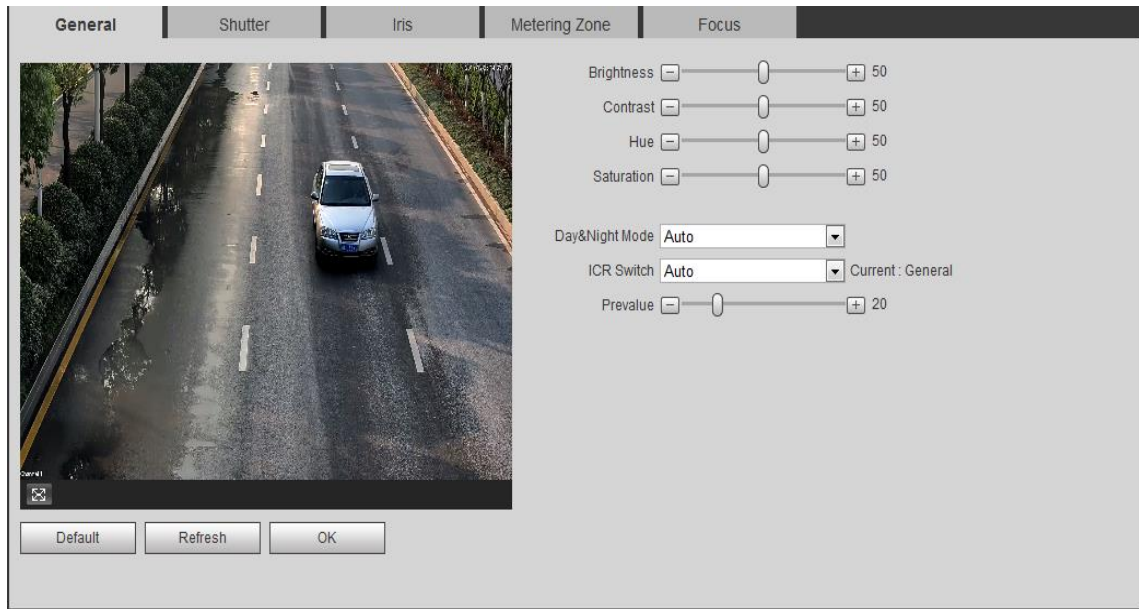

Figure 6-50 General

Please refer to the following sheet for log parameter information.

Parameter	Function
Brightness	The value adjusts brightness of full image. Default value is 50. The higher the value, the brighter the image. When image is too bright or too dark, you may adjust this value. Recommended value is 40~60 within 0~100 range.
Contrast	The value adjusts contrast of full image. Default value is 50. The higher the value, the higher the contrast of image. When contrast is insufficient, you may adjust this value. Recommended value is 40~60 within 0~100 range.
Hue	The value adjusts hue of image. Default value is 50. It will not affect image brightness. It has a relatively fixed value according to the sensor. Recommended value is 40~60 within 0~100 range.
Saturation	The value adjusts saturation of image. Default value is 50. The higher the value, the deeper the color. It will not affect image brightness. When WDB is inaccurate, this value may cause color difference in grey area. Recommended value is 40~60 within 0~100 range.
Day/Night mode	Switch of color and black&white. It includes color, by brightness and black&white.

Parameter	Function
ICR Switch	ICR switch: <ul style="list-style-type: none"> <li>● Auto: Automatically switch according to the brightness</li> <li>● General: Normal operation</li> <li>● CPL: Night filter switching equipment</li> </ul>

Chart 6-21

### 6.5.2.1.2 Shutter

The shutter interface is shown as in Figure 6-51 Shutter.

Select Setting>Camera>Attributes>Shutter.

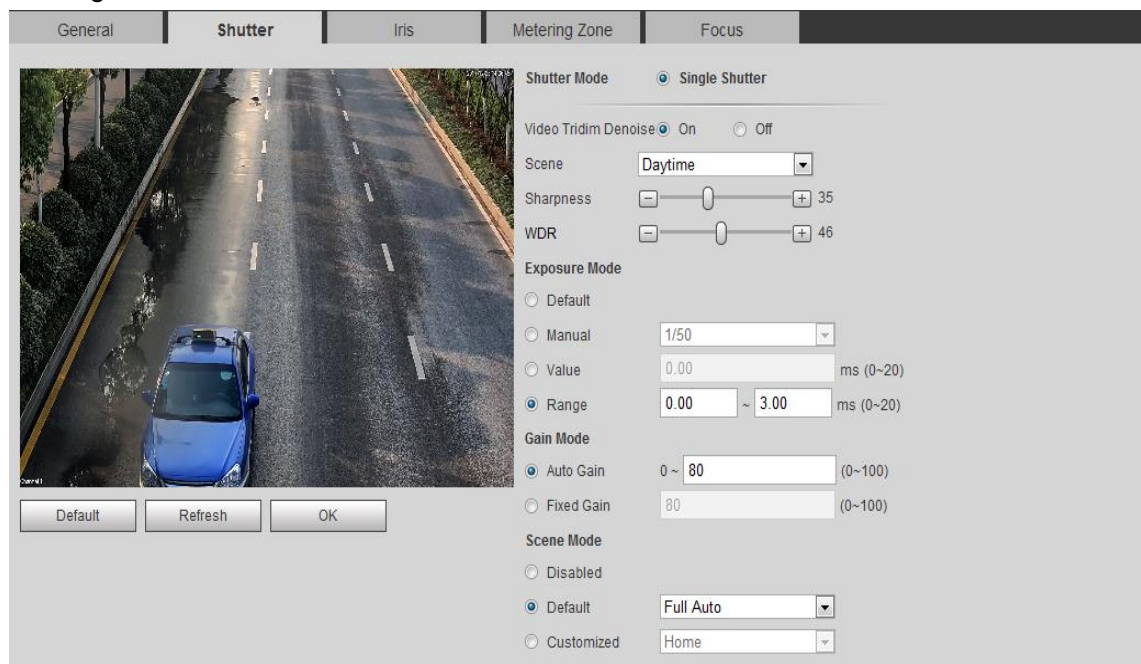

Figure 6-51 Shutter

Please refer to the following sheet for log parameter information.

Parameter	Function
Shutter mode	Support single shutter, picture exposure mode, scene mode, gain mode can be separately set.
Video Tridim Denoise	Select ON, to enable 3D NR.
Scene	Switch to other scenes to change sharpness.

Exposure mode	Select exposure mode: auto and manual. You can set manual exposure mode as 1/50~1/10000. You may also customize.
Scene mode	Set scene mode according to device environment. <ul style="list-style-type: none"> <li>● Disabled: disable scene mode.</li> <li>● Default : select Full Auto, High Color Temperature, Low Color Temperature, Auto Color Temperature or Partial Auto.</li> <li>● Customized: select Home, Office, Night or Customized Color Temp.</li> </ul>
Sharpness	Set sharpness of each scene. The higher the value, the higher the contrast of detail will be and the image is clearer. But when this value is too high, image will have higher noise.
WDR	Set WDR of each scene. Lower brightness in highly bright area, and improve brightness in relatively dark area, so images in these areas can both be clear. The higher the value, the higher the WDR will be.
Gain mode	<ul style="list-style-type: none"> <li>● Auto gain, set auto gain range.</li> <li>● Fixed gain, set fixed gain value.</li> </ul>

### 6.5.2.1.3 Iris

By adjusting step length, you can adjust image effect. See Figure 6-52 Iris.

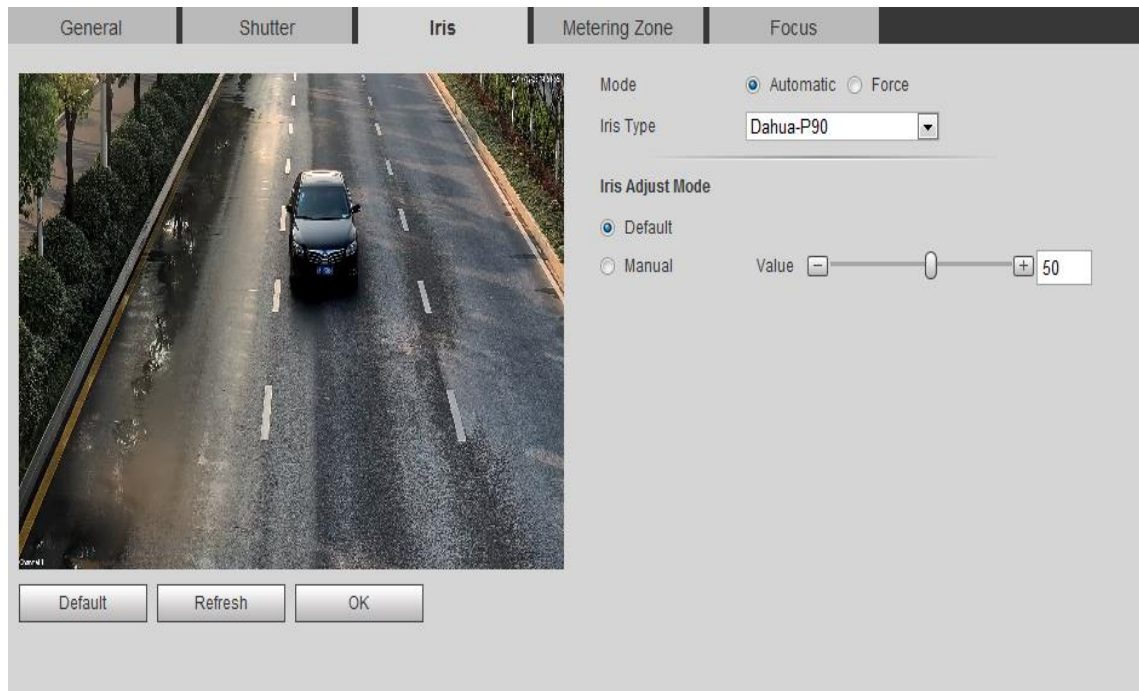

Figure 6-52 Iris

Parameter	Note
Iris Type	Select current lens to use.
Iris Adjust Mode	Select iris adjust method. Different lens types have different adjustment of iris. <ul style="list-style-type: none"> <li>● Default: auto adjust.</li> <li>● Manual: manually adjust.</li> </ul>

Chart 6-22

#### 6.5.2.1.4 Metering Zone

The metering zone interface is shown as in Figure 6-53 Metering Zone.

Select Setting>Camera>Attributes>Metering Zone.

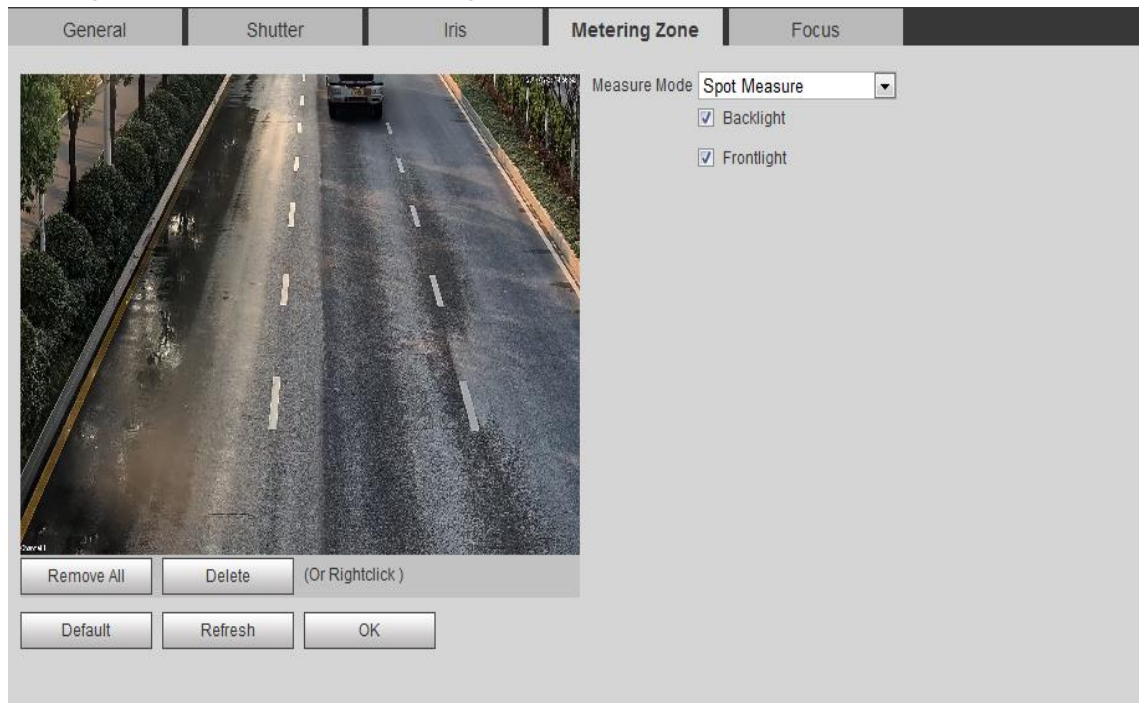

Figure 6-53 Metering Zone

Please refer to the following sheet for log parameter information.

Parameter	Function
Metering zone	<ul style="list-style-type: none"> <li>● Spot measure: For moving vehicle.</li> <li>● Full measure: For entire zone.</li> <li>● Partial measure: For sensitive zone. If the zone is bright, entire zone will be dark and vice versa.</li> </ul>
Backlight/Front light	<p>According to actual condition, select backlight or front light.</p> <p>Note:</p> <p>Spot measure only.</p>



### 6.5.2.1.5 Focus

This is auto focus function, and you can one-click complete adjustment.

Step 1. Setting>Camera>Attributes>Focus.

See Figure 6-54.

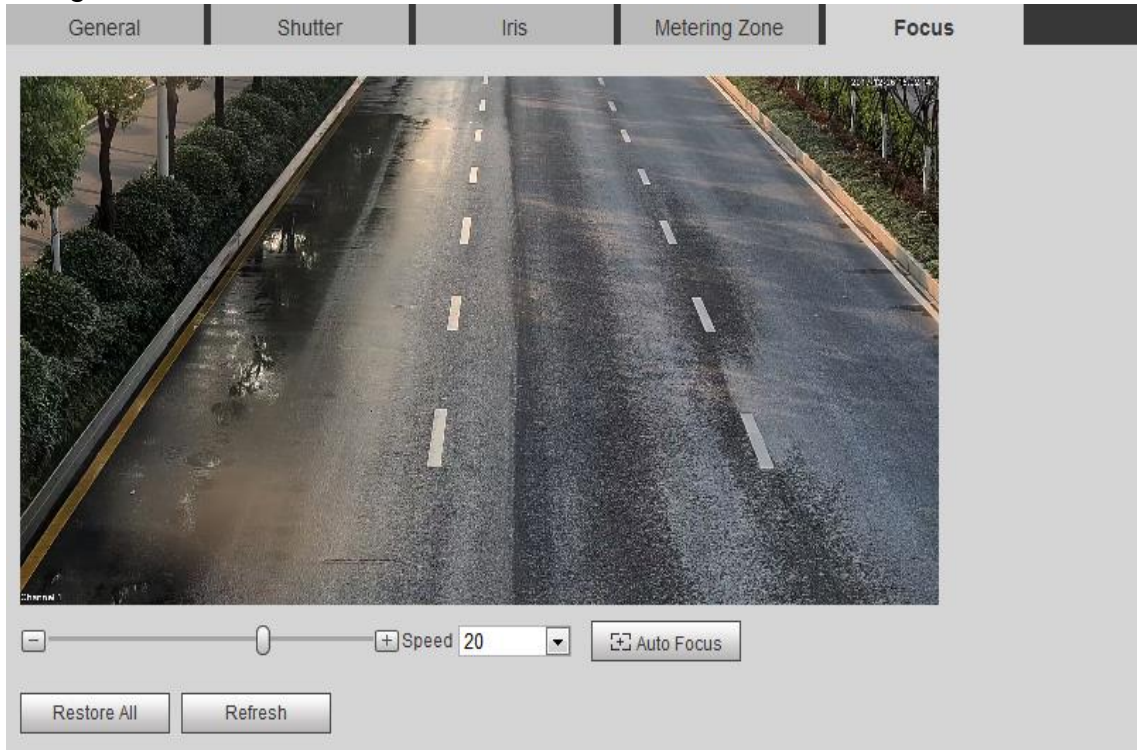

Figure 6-54

Step 2. Drag the bar to see speed size.

Step 3. Click dropdown list below Speed, set ABF speed. The higher the value, the faster the speed will be.

Step 4. Click Auto Focus to auto set focus within monitoring video.

### 6.5.2.2 Video

#### 6.5.2.2.1 Video

The video interface is shown as in Figure 6-55 Video.

Setting>Camera>Video>Video.

The screenshot shows a configuration window for video settings. It has three tabs at the top: 'Video' (selected), 'Snapshot', and 'Interest Area'. Below the tabs are two main sections: 'Main Stream' and 'Sub Stream'.

**Main Stream Settings:**

- Code-Stream Type: General
- Encode Mode: H.264H
- Resolution: 1920\*1080(1080P)
- Frame Rate(FPS): 25
- Bit Rate Type: CBR
- Bit Rate: Customized
- Bit Rate Value: 4096
- I Frame Interval: 50 (range 25~150)
- Watermark Settings:  (checked)
- Watermark Character: DigitalCCTV

**Sub Stream Settings:**

- Enable:  (unchecked)
- Code-Stream Type: General
- Encode Mode: H.264M
- Resolution: 704\*576(D1)
- Frame Rate(FPS): 25
- Bit Rate Type: VBR
- Quality: Better
- Bit Rate: 512
- I Frame Interval: 50 (range 25~150)

At the bottom of the window are three buttons: 'Default', 'Refresh', and 'OK'.

Figure 6-55 Video

Please refer to the following sheet for log parameter information.

Parameter	Function	
Main stream	Code-stream type	Support only general stream.
	Encode mode	It supports H.264B, H.264M, H.264H, MJPEG and H.265.
	Resolution	Display resolution, which differ according to camera model.
	Frame rate (FPS)	Different model supports max FPS.
	Bit rate type	It includes: CBR and VBR. Under VBR, you can set image quality.
	Bit rate	<ul style="list-style-type: none"> <li>Under VBR, this value serves as upper limit. Under CBR, this value is fixed.</li> </ul>
	I frame interval	It is the P frame between two I frame, with range 1 ~ 150. Default is two times frame rate.
	Watermark settings	By verifying watermark character, you may check if record is edited. Check front box to enable function. Default watermark character is: DigitalCCTV. Only number, letter, and underline are supported, max 85 characters.
Watermark Character	Default character: DigitalCCTV. Only contain number, letter, underline and max is 85 characters.	

Parameter	Function	
Sub Stream	Enable	Control the secondary stream is turned on. The default is not open.
	Code Stream Type	General stream.
	Encode Mode	Currently only supports H.264B, H.264M, H.264H, MJPEG, and H.265.
	Resolution	Currently it supports up to UXGA, 720P, D1, CIF. Note: Sub stream cannot exceed main stream.
	FPS	Different maximum resolution supported by the frame rate.
	Bit Rate Type	Including fixed stream or variable code stream. Only in VBR mode can be set image quality at a fixed stream mode is not set quality.
	Quality	Under VBR, you can set quality, 6 levels available.
	Bit Rate	<ul style="list-style-type: none"> <li>● In the fixed stream mode, which is the upper limit value stream stream. Under dynamic images, if necessary by reducing the frame rate and image quality will be to ensure that the stream does not exceed the value.</li> <li>● In VBR mode, this value has no meaning.</li> <li>● Refer to "stream reference value" - the value stream to provide the best reference range.</li> </ul>
I Frame Interval	Number of P frames between two I-frames, the frame rate due to changes in the scope of change, a maximum of 150, it is recommended to the frame rate of 2 times.	

### 6.5.2.2.2 Snapshot

The snapshot interface is shown as in Figure 6-73 Relay-out.

Select Setting>Camera>Video>Snapshot.

The screenshot shows a configuration window with three tabs: "Video", "Snapshot" (which is active), and "Interest Area". The "Snapshot" tab contains the following settings:

- Snapshot Type:** A dropdown menu set to "General Snap".
- Pic Size:** A text field showing "1920\*1080(1080P)".
- Quality:** A radio button is selected next to the label "Quality". The dropdown menu is set to "Better".
- Picture Coding Size (KB):** A radio button is selected next to the label "Picture Coding Size (KB)". The dropdown menu is set to "300".

At the bottom of the window, there are three buttons: "Default", "Refresh", and "OK".



Figure 6-56 Snapshot

Please refer to the following sheet for log parameter information.

Parameter	Function
Snapshot type	It includes general snap and trigger snap. General snap works within predetermined time period. Trigger snap works at time of motion detect, privacy masking and relay activation. <b>Note:</b> This device does not support this function.
Pic size	Be consistent with main stream resolution. <b>Note:</b> This device does not support this function.
Quality	Select snap quality from 6 levels.
Picture coding size (KB)	Set picture coding size. <b>Note:</b> <b>Please select either quality or picture coding size.</b>

### 6.5.2.2.3 Interest Area

The interest area interface is shown as in Figure 6-57 Interest Area.

Select Setting>Camera>Video>Interest Area.

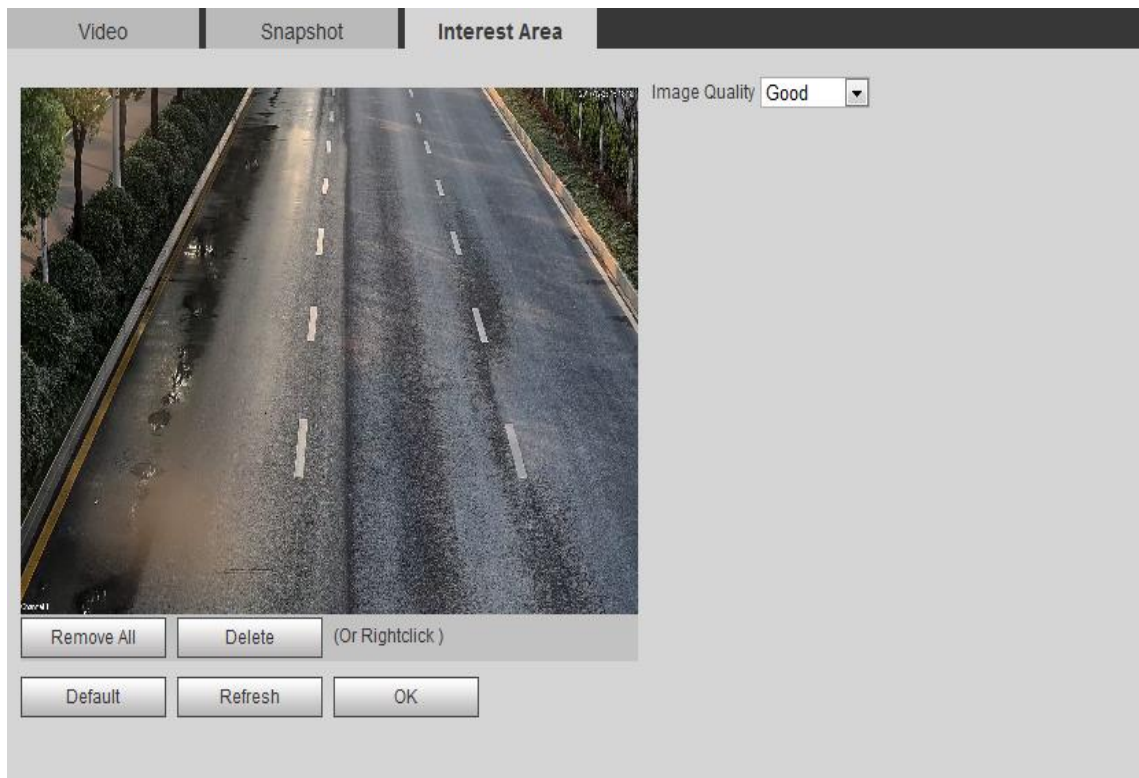

Figure 6-57 Interest Area

Please refer to the following sheet for log parameter information.

Parameter	Function
Image quality	<ul style="list-style-type: none"><li>● You may drag left mouse to set interest area.</li><li>● Select snap quality from 6 levels.</li></ul>
Remove All	<ul style="list-style-type: none"><li>● Click it to delete all set area.</li></ul>
Delete	<ul style="list-style-type: none"><li>● Click it delete the most recent interest area. You can keep clicking it. Or, you can right click in any position of video to delete the interest area.</li></ul>

Chart 6-23

### 6.5.3 Network

#### 6.5.3.1 TCP/IP

The TCP/IP interface is shown as in Figure 6-58 TCP/IP.

Select Setting>Network>TCP/IP.

**Warning:**

**Some models support dual Ethernet ports, please DO NOT set them to the same segment.**

**TCP/IP**

Host Name: ITC

Ethernet Card: Wire( Default)

Mode:  Static  DHCP

MAC Address: e0 . 50 . 8b . cb . 49 . 06

IP Version: IPv4

IP Address: 172 . 32 . 4 . 209

Subnet Mask: 255 . 255 . 0 . 0

Default Gateway: 172 . 32 . 0 . 1

Preferred DNS: 8 . 8 . 8 . 8

Alternate DNS: 8 . 8 . 8 . 8

Refresh OK

Figure 6-58 TCP/IP

Please refer to the following sheet for log parameter information.

Parameter	Function
Host name	Set current host name. Max supports 32 characters.
Ethernet card	Set Ethernet card to config. Default is wired. Note: For model with -W, you can use wireless Ethernet card and edit card. You must reboot device if you have set default card. Currently it only supports wired.
Mode	You can select from static and DHCP mode. In DHCP mode, it automatically search IP while you cannot set IP/subnet mask/gateway. Plus IP/subnet mask/gateway display values from DHCP. In static mode, you shall manually set IP/subnet mask/gateway. To switch from DHCP to static, you must set IP parameters again.

Parameter	Function
MAC address	Display host MAC address.
IP version	Select IP version IPV4 or IPV6. These two IP addresses both can be accessed.
IP address	Input new IP address to edit, and set subnet mask and default gateway.
Subnet Mask	Device IP address corresponding subnet mask.
Default Gateway	Device IP address corresponding default gateway.
Preferred DNS	DNS server IP address.
Alternate DNS	DNS server alternate IP address.

Chart 6-24

### 6.5.3.2 Connection

#### 6.5.3.2.1 Connection

Set port parameters.

Parameter	Note
Max Connection	Max connection (1~10)
TCP Port	Set TCP port (1025~65535)
UDP Port	Set UDP port (1025~65535)
HTTP Port	Set HTTP port
HTTPs Port	Set HTTPs port

Chart 6-25

#### 6.5.3.2.2 ONVIF User

ONVIF is Open Network Video Interface Forum, an online video to achieve a framework agreement, which are produced by different vendors of network video products (such as front-end cameras, video equipment, etc.) is fully interoperable.

Check the open ONVIF login, login ONVIF need a username and password verification; turn off the feature you do not need validation. See Figure 6-59 ONVIF.

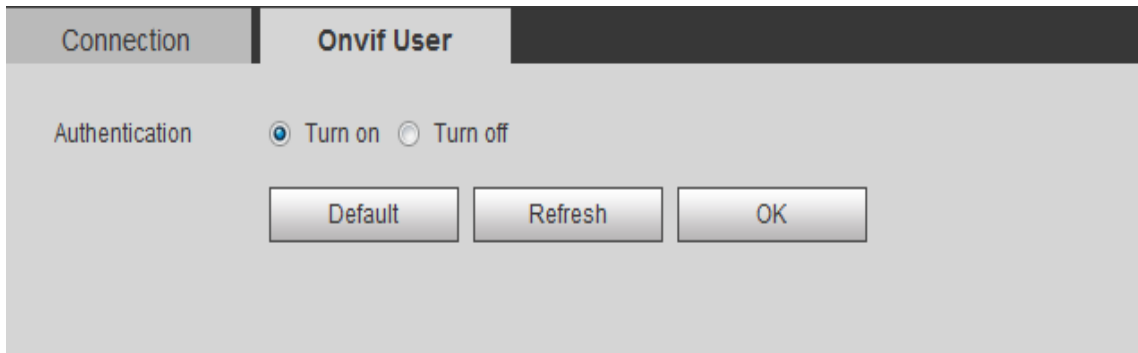

Figure 6-59 ONVIF

### 6.5.3.3 Auto Register

Enable auto register function. When the device connects to WAN, it will reports user position to specified server periodically, so client software can access device, preview and monitor via server. Select Setting>Network>Auto Register, see Figure 6-60.

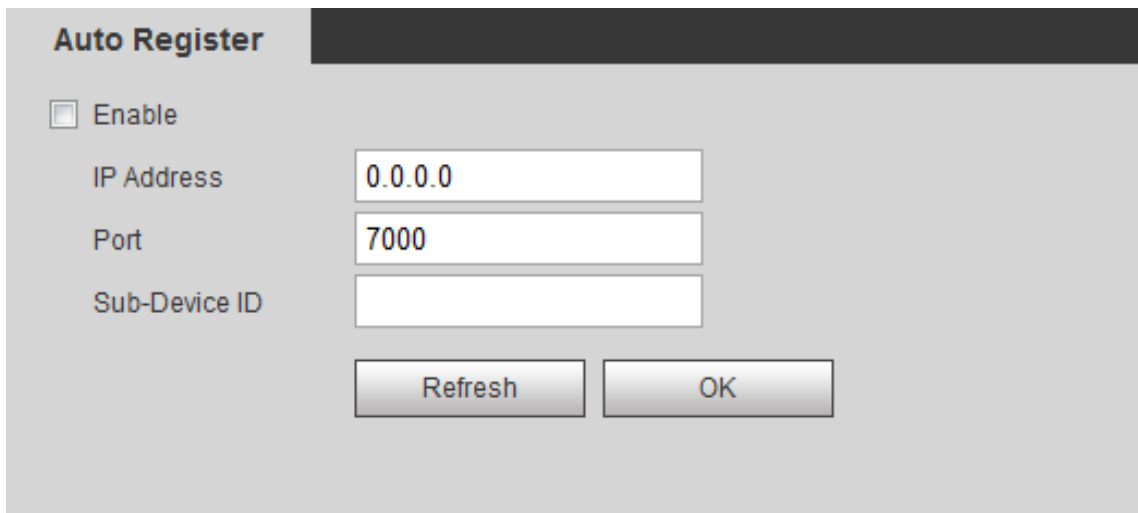

Figure 6-60

Parameter	Note
Enable	Select and enable auto register.
IP Address	Need to register to server IP address.
Port	Server used to auto register port no.
Sub-Device ID	Auto register device ID allocated by server. For config, must ensure auto connection to device SN.

Chart 6-26

### 6.5.3.4 HTTPS

In HTTPS setup interface, a user can make PC pass HTTPS by creating certificate or upload signed certificate.

### Create Customized Certificate and Install

Step 1. Select Setting>Network>HTTPS. See Figure 6-61.

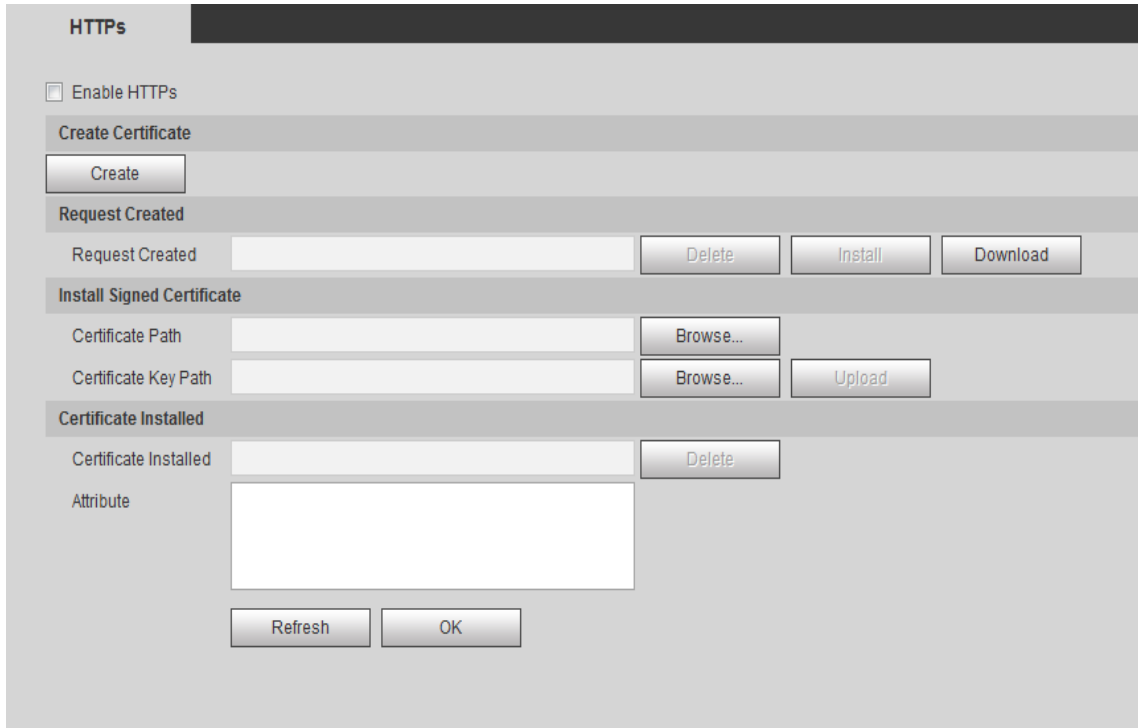

Figure 6-61

Step 2. Create certificate.

Step 1. Click Create, see

Figure 6-62

Step 2. Set HTTPS parameter, see

Parameter	Note
Country	Initial of country name. Two upper cases only.
IP or Domain name	Device IP address.
Validity	Certificate validity.
Province	Province of certificate usage
Location	Location of certificate usage
Organization	Organization of certificate usage
Organization Unit	Organization name of certificate usage
Email	Personal email or unit email of certificate usage

Chart 6-27

Step 3. Click Create.

After you create certificate, you can see the request in created request area.

Step 3. Click Install.

**Note:**

**Click Delete in “Certificate Installed” area, to delete installed certificate.**

Step 4. Click Download to download root certificate.

Step 5. Install root certificate.

Step 1. Double click  RootCert.cer , see Figure 6-63.

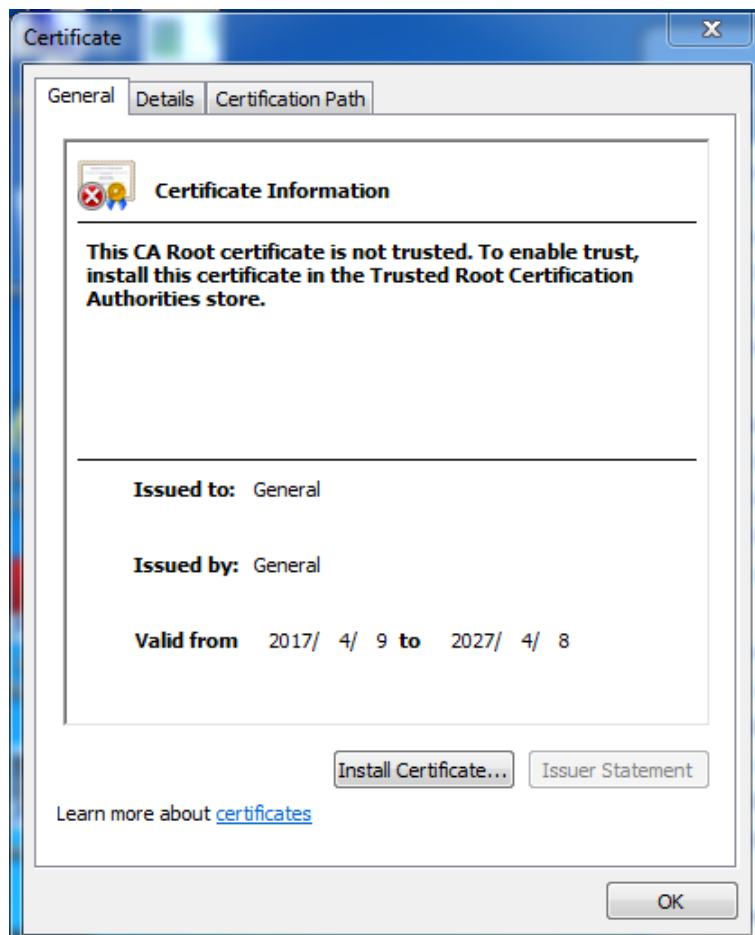

Figure 6-63

Step 2. Click Install Certificate. See Figure 6-64.





Figure 6-64

Step 3. Click Next, see Figure 6-65.

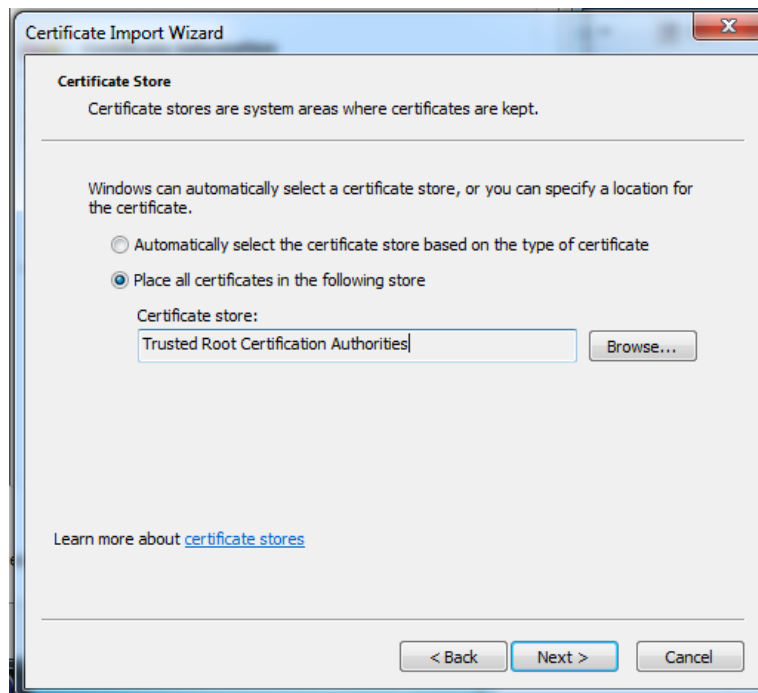

Figure 6-65

Step 4. Select Place all certificate in the following store, click Browse. Set Certificate to be “Trusted Root Certification Authorities”, and click Next.

The following is wizard interface.

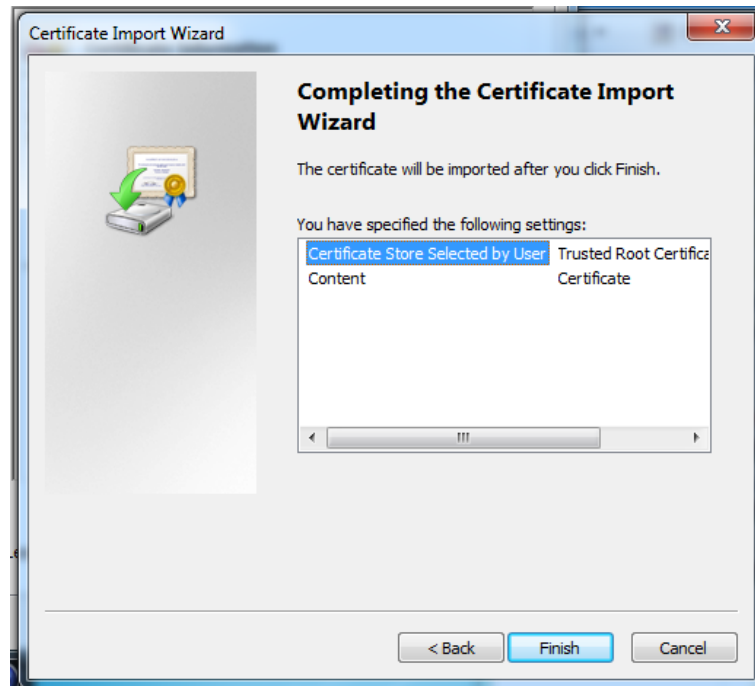

Figure 6-66

Step 5. Click Finish.

In pop up Security Warning box, click Yes. Then Click OK. Import is complete.

Step 6. Click OK. Instalaltion is complete.

Device starts to reboot. After reboot complete, in Internet Explorer, enter `http:// device IP`, to access the device.

### Install Signed Certificate

After it gets signed certificate and key from digital signature organization, it can import signed certificate and certificate key.

Step 1. Select Setting>Network>HTTPs, see Figure 6-67.

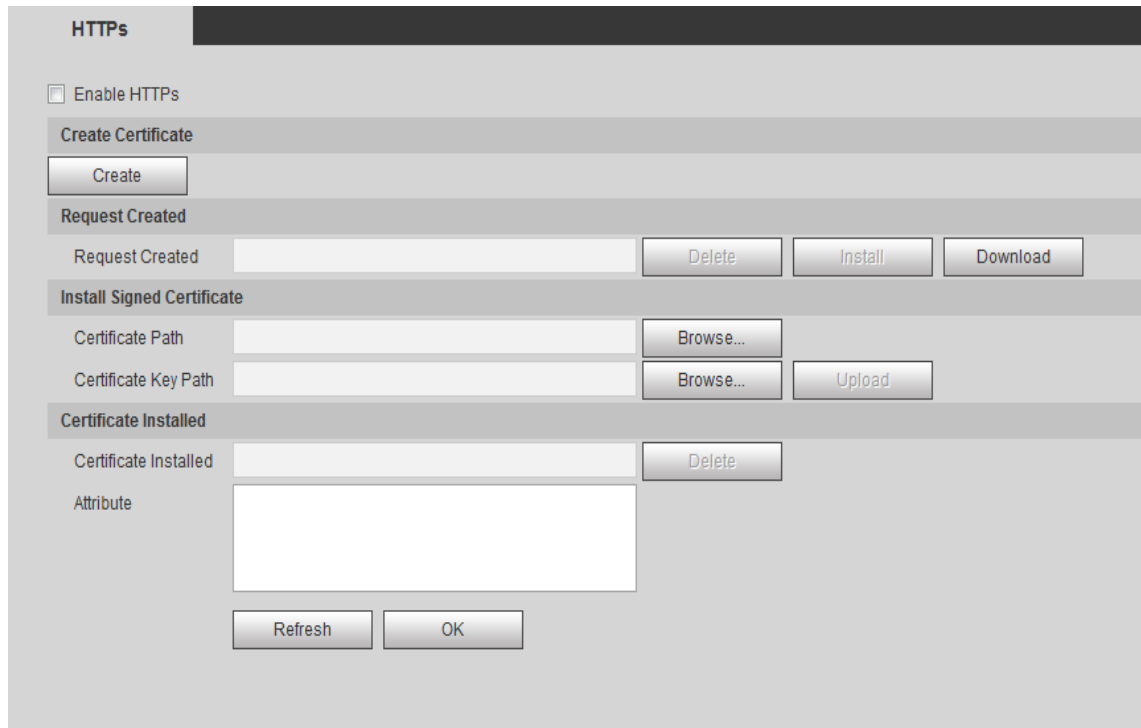



Figure 6-67

- Step 2. Click Certificate Path's corresponding "Browse", and select signed certificate file. Click Certificate Key Path's corresponding "Browse" to select key file of signed certificate.
- Step 3. Click Upload.  
The system starts to install certificate, and after complete, it generate property of the certificate in installation area.
- Note:**  
**Click Delete in Certificate Installed area to delete the installed certificate.**
- Step 4. Click Download to save root certificate.
- Step 5. Install root certificate.
1. Double click  RootCert.cer . See Figure 6-68.

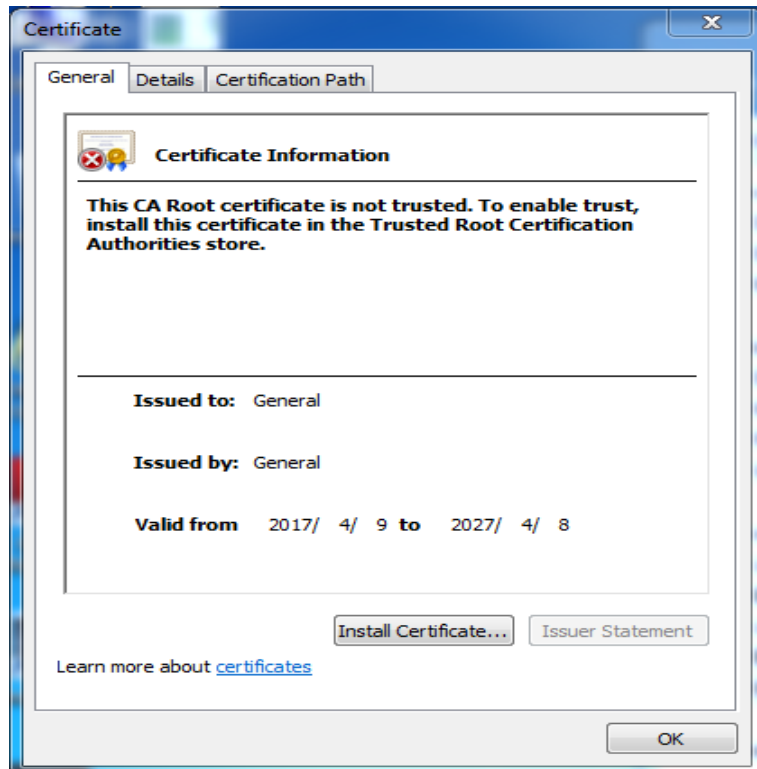

Figure 6-68

2. Click Install Certificate.  
See Figure 6-69.

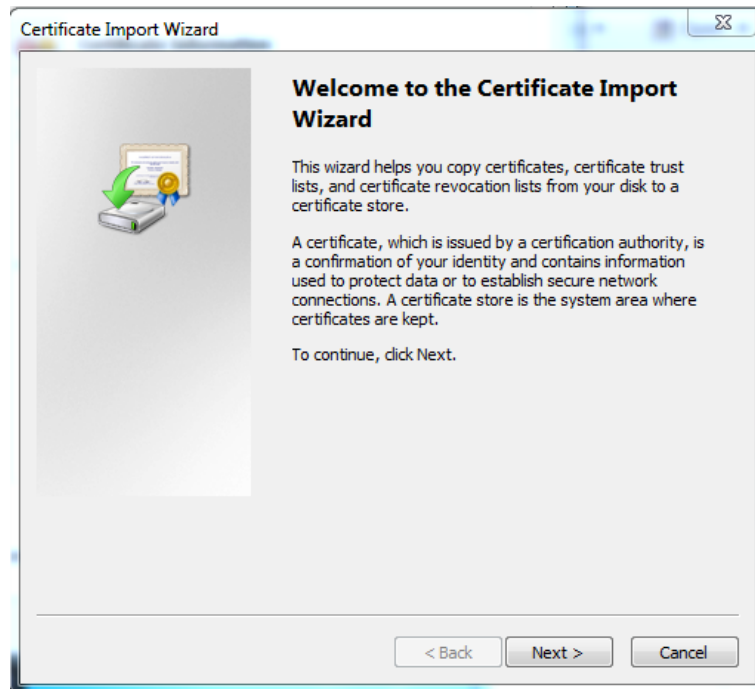

Figure 6-69

3. Click Next, see Figure 6-70.

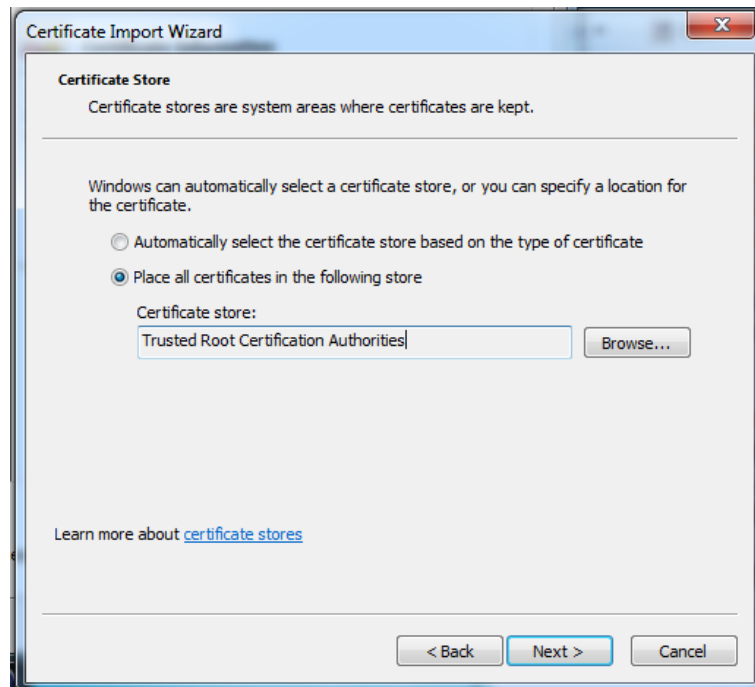

Figure 6-70

4. Select "Place all certificate in the following store", click "Browse" and set "Certificate Store" to be "Trusted Root Certification Authorities", click Next.

See Figure 6-71.

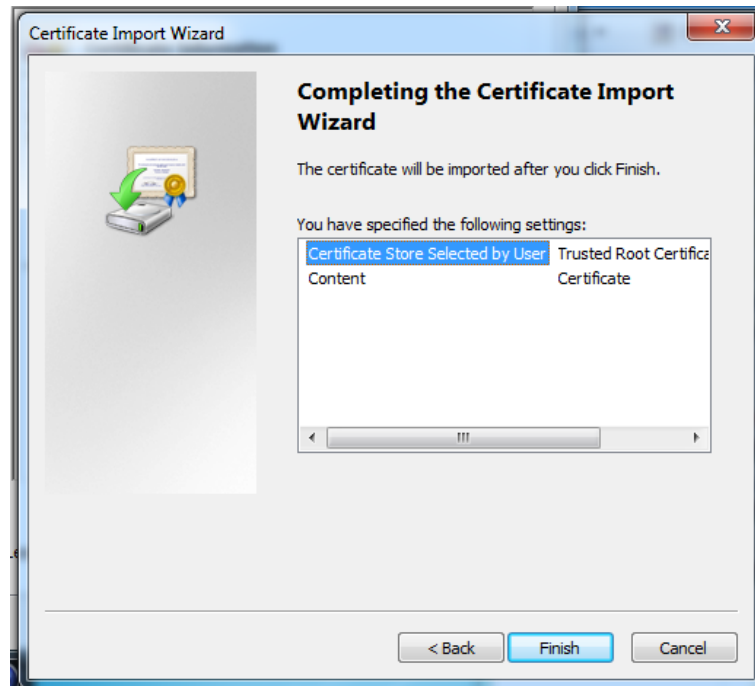

Figure 6-71

5. Click Finish. In pop-up Security Warning box, click OK. And click OK again.
6. Click OK.

Step 6. Select Enable HTTPs, click OK.

Device starts to reboot. After reboot complete, in Internet Explorer, enter `http:// device IP`, to access the device.

## 6.5.4 Event

### 6.5.4.1 Alarm

#### 6.5.4.1.1 Relay activation

The relay activation interface is shown as in Figure 6-72 Relay Activation.

- Step 1. Select Setting>Event>Alarm>Relay Activation. \

Figure 6-72 Relay Activation

Step 2. Select Enable.

Step 3. Set alarm parameters.

Please refer to the following sheet for log parameter information.

Parameter	Function
Relay-in	Support 2 channels of alarm input.
Period	Set alarm arm and disarm period. Click on setup button to open period menu.
Anti-dither	During anti-dither period, only one alarm will be recorded. Unit is second with range 0s~100 s.
Sensor type	May set NO or NC.

Chart 6-28

Step 4. Select Relay-out accordingly, and set port no. and alarm delay time.

Step 5. Click OK.

#### 6.5.4.1.2 Relay-out

The relay-out interface is shown as in Figure 6-73 Relay-out.

Step 1. Select Setting>Event>Alarm>Relay-out.



Figure 6-73 Relay-out

Step 2. Click 1, 2, or 3. Set 1 channel of alarm output.

Step 3. Click trigger to output alarm signal.

Step 4. Click Refresh to search alarm output status.

#### 6.5.4.2 Abnormity

When the device has abnormality, the system will trigger alarm.

Select Setting>Event>Abnormality, select abnormality tab, see figure shown below.

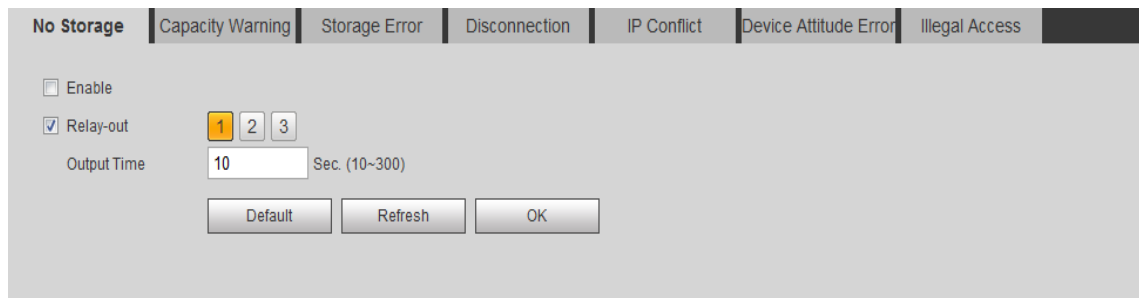

Figure 6-74 No Storage Card

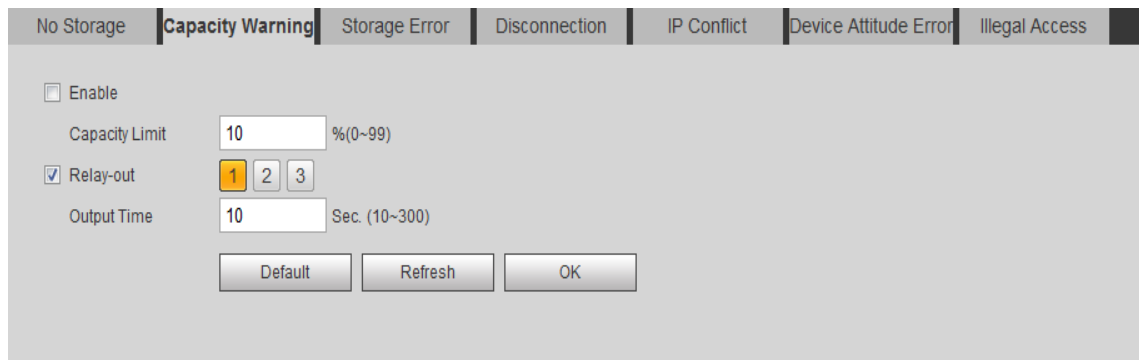



Figure 6-75 Capacity Warning



The screenshot shows a configuration page with a top navigation bar containing tabs: No Storage, Capacity Warning, Storage Error, Disconnection, IP Conflict, Device Attitude Error, and Illegal Access. The 'Capacity Warning' tab is selected. The main content area includes:

- An 'Enable' checkbox, which is unchecked.
- A 'Relay-out' checkbox, which is checked.
- A numeric keypad with three buttons labeled '1', '2', and '3'. The '1' button is highlighted in yellow.
- An 'Output Time' input field containing the value '10', followed by the text 'Sec. (10-300)'.
- Three buttons at the bottom: 'Default', 'Refresh', and 'OK'.

Figure 6-76 Storage Error



The screenshot shows a configuration page with a top navigation bar containing tabs: No Storage, Capacity Warning, Storage Error, Disconnection, IP Conflict, Device Attitude Error, and Illegal Access. The 'Storage Error' tab is selected. The main content area includes:

- An 'Enable' checkbox, which is unchecked.
- A 'Relay-out' checkbox, which is unchecked.
- A numeric keypad with three buttons labeled '1', '2', and '3'. The '1' button is highlighted in yellow.
- An 'Output Time' input field containing the value '10', followed by the text 'Sec. (10-300)'.
- Three buttons at the bottom: 'Default', 'Refresh', and 'OK'.

Figure 6-77 Disconnection



The screenshot shows a configuration page with a top navigation bar containing tabs: No Storage, Capacity Warning, Storage Error, Disconnection, IP Conflict, Device Attitude Error, and Illegal Access. The 'Disconnection' tab is selected. The main content area includes:

- An 'Enable' checkbox, which is unchecked.
- A 'Relay-out' checkbox, which is unchecked.
- A numeric keypad with three buttons labeled '1', '2', and '3'. The '1' button is highlighted in yellow.
- An 'Output Time' input field containing the value '10', followed by the text 'Sec. (10-300)'.
- Three buttons at the bottom: 'Default', 'Refresh', and 'OK'.

Figure 6-78 IP Conflict

No Storage | Capacity Warning | Storage Error | Disconnection | IP Conflict | **Device Attitude Error** | Illegal Access

Enable

Rollover Angel  °

Threshold

Pitch Angle Threshold  °

Acceleration  m/s<sup>2</sup>

Threshold

Relay-out

Output Time  Sec. (10~300)

Figure 6-79 Device Attitude Error

No Storage | Capacity Warning | Storage Error | Disconnection | IP Conflict | **Device Attitude Error** | **Illegal Access**

Enable

Login Error  time (3~10)

Relay-out

Output Time  Sec. (10~300)

Figure 6-80 Illegal Parking

Please refer to the following sheet for log parameter information.

Parameter	Function
Enable	Check box to enable this function.
Relay-out	When alarm occurs, set corresponding relay out. You must enable this function first.
Output Time	Alarm will continue for X seconds after motion detect ends. You can set X within 10 s~300 s.
Login Error	Set allowance of login error, range is 3-10.
Rollover Angle Threshold	Set rollover angle threshold, unit is degree.
Pitch Angle Threshold	Set pitch angle threshold, unit is degree.

Parameter	Function
Acceleration Threshold	Set acceleration threshold, unit is degree.

Chart 6-29

### 6.5.4.3 IVS Event

#### 6.5.4.3.1 Pedestrian

When it detects pedestrian in detection zone, it will trigger alarm.

Step 1. Select Setting>Event>IVS Event>Pedestrian. See Figure 6-81.

Figure 6-81

Step 2. Set parameters.

Parameter	Note
Lane	Select lane no. of detection zone.
Snapshot	Select to enable snapshot.

Chart 6-30

Step 3. Click OK.

#### 6.5.4.3.2 Parking

When detection zone has parking event, it will trigger alarm.

Step 1. Select Setting>Event>IVS Event>Parking, see Figure 6-82.

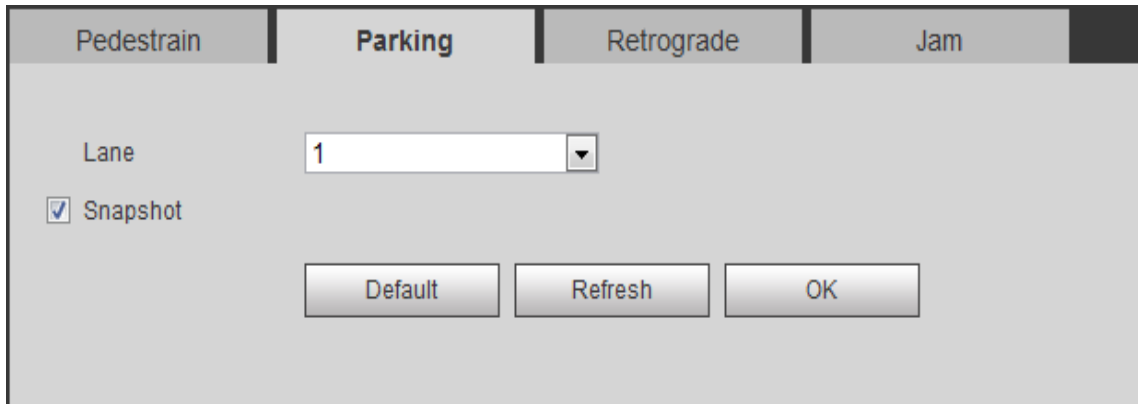

Figure 6-82

Step 2. Set parameters, see Chart 6-31.

Parameter	Note
Lane	Select lane no. of detection zone.
Snapshot	Select to enable snapshot.

Chart 6-31

Step 3. Click OK.

#### 6.5.4.3.3 Retrograde

Select>Event>IVS Event>Retrograde, see Figure 6-83.

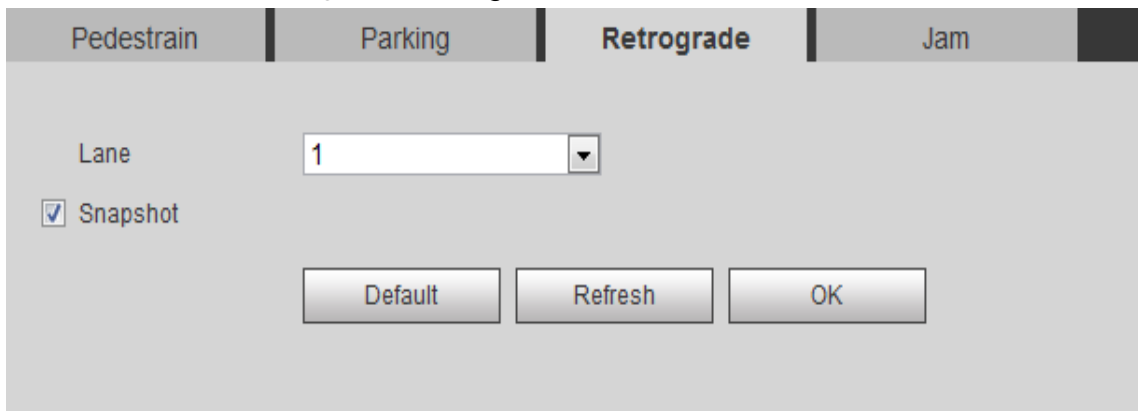

Figure 6-83

#### 6.5.4.3.4 Jam

When traffic jam occurs, it will trigger alarm.

See Figure 6-84.

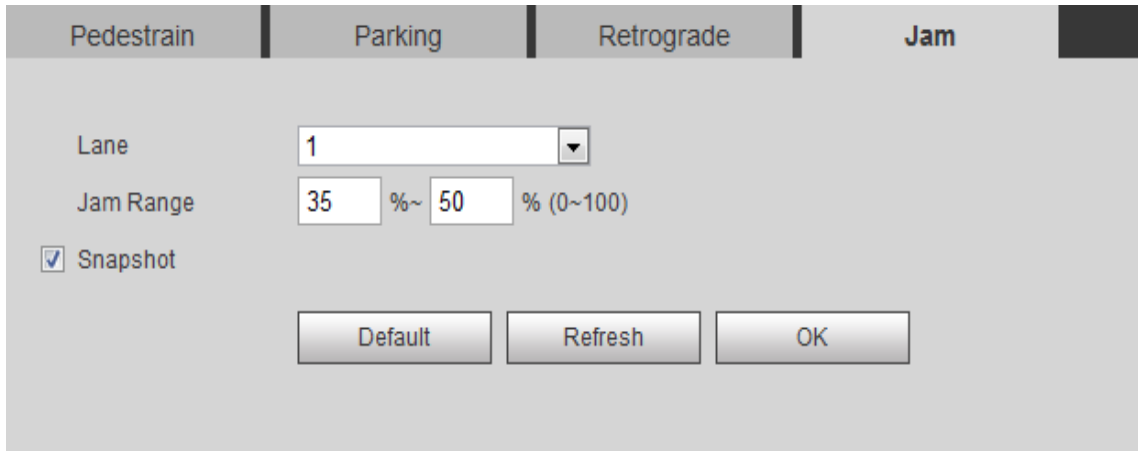

Figure 6-84

Parameter	Note
Lane	Select lane no. in detection area.
Jam Range	Percentage of jam
Snapshot	Select to enable snapshot

Chart 6-32

## 6.5.5 Storage

### 6.5.5.1 Destination

#### 6.5.5.1.1 Point

Set storage of snapshot and record. Snapshot event has local storage and FTP. Record event has local storage.

Select Setting>Storage>Destination>Point, select storage method for snapshot and record. See

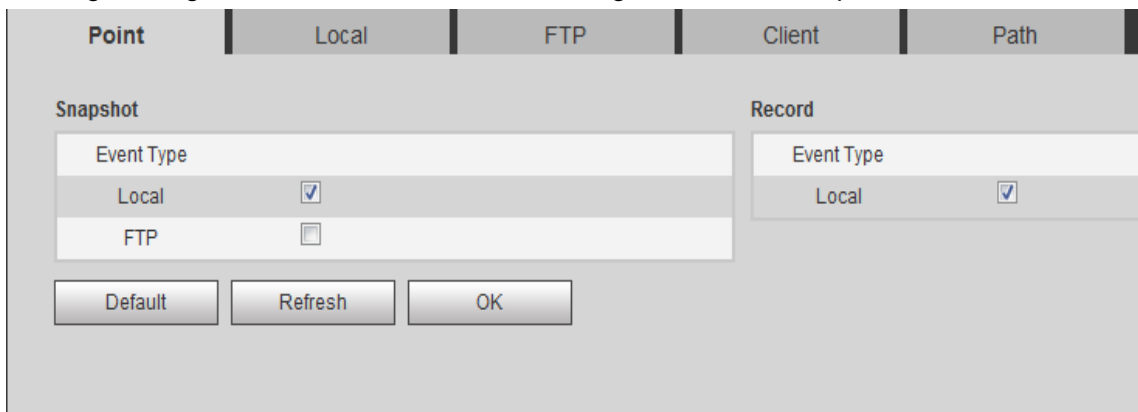

Figure 6-85

#### 6.5.5.1.2 Local

The list shows FT card info, and you can format it and select whether to overwrite or stop storage when disk is full.

Select Setting>Storage>Destination>Local, see Figure 6-86 Local.

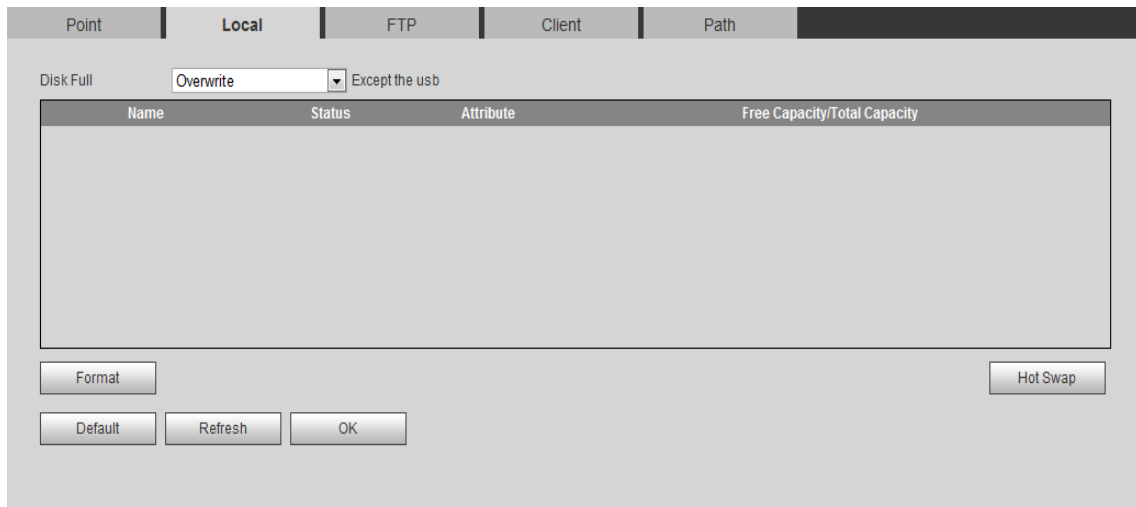

Figure 6-86 Local

### 6.5.5.1.3 FTP

FTP: You must enable FTP before selecting it for current storage. When disconnection occurs or malfunctions, it saves file or snapshot to local TF card. See Figure 6-87 FTP.

Point | Local | **FTP** | Client | Path

Offline Transfer

FTP Named

**Server1** | Server2 | Server3

Enable

Server IP  .  .

Encode Mode

Port  (0-65535)

Username

Password

Upload Type

Picture Type	Original Picture	CutOut Picture
All	<input checked="" type="checkbox"/>	<input type="checkbox"/>
ManualSnap	<input checked="" type="checkbox"/>	<input type="checkbox"/>
ANPR	<input checked="" type="checkbox"/>	<input type="checkbox"/>
Retrograde	<input checked="" type="checkbox"/>	<input type="checkbox"/>

Figure 6-87 FTP

Parameter	Note
Offline Transfer	When the network is disconnected or failed, you can save the image to the local memory card, to be automatically restored after the network upload to the FTP server or platform.
Server 1, Server 2, Server 3	Support FTP upload, to upload event to different FTP servers.
Enable	Enable the FTP server storage point.
Server IP	The IP address of the FTP server.
Encode Mode	Picture naming for the Chinese character encoding, there are two optional UTF-8 and GB2312. When you click Test, two files that use UTF-8 and GB2312 encoding, respectively, are created on the FTP server to determine how the server is encoded.
Port	FTP server port
Username and Password	FTP server username and password
Upload Type	Select event type and corresponding picture, record to upload.

Chart 6-33

#### 6.5.5.1.4 Client

- Check the "Offline transfer", when the network is disconnected or faulty, you can save a picture to capture the local TF card, until the network is restored, the server automatically uploaded to the platform.
- Upload by IP address or MAX address.
- Max support two platforms.
- Quickly add platform: client Browse to view IP and MAC address of all online platform, select one address and click OK to add.

See Figure 6-88 Client.

The screenshot shows a software interface with a tabbed header containing 'Point', 'Local', 'FTP', 'Client', and 'Path'. The 'Client' tab is active. Below the header, there is a checkbox labeled 'Offline Transfer'. Underneath, the 'Type' section has two radio buttons: 'IP' (which is selected) and 'MAC'. The 'Server' section features a dropdown menu currently showing 'Server1' and a 'Browse...' button to its right. Below that is a 'ServerIP' input field with a dotted pattern. At the bottom of the form are three buttons: 'Default', 'Refresh', and 'OK'.

Figure 6-88 Client

#### 6.5.5.1.5 Path

Path: Config record and snapshot, includes: local TF card storage and FTP storage. You cannot select local and local emergency at the same time. The path interface is shown as in Figure 6-89 Path.



Point	Local	FTP	Client	Path
<b>Picture Naming And Store Path</b>				
Input Name	<input type="text" value="Alarm Picture\%y%\%M%\%d%\%h%\%07%\%y%\%M%\%d%\%h%\%m%\%s%\%S_%04_%14_%09_%13_%27"/>			<input type="button" value="Reset"/>
Name Preview	<input type="text" value="Alarm Picture\2013\01\06\15"/> <input type="text" value="\ANPR\20130106152730110_2_2_EUP"/>			<input type="button" value="Help..."/>
<b>Record And Picture Path</b>				
Picture Path	<input type="text" value="C:\PictureDownload"/>			<input type="button" value="Browse..."/>
Record Path	<input type="text" value="C:\RecordDownload"/>			<input type="button" value="Browse..."/>
<input type="button" value="Default"/> <input type="button" value="Refresh"/> <input type="button" value="OK"/>				

Figure 6-89 Path

### 6.5.5.2 Record Control

Select record mode and record stream. If you select Off for record mode, then you cannot link record. See Figure 6-90 Record Control.

Select Setting>Storage>Record Control, select Automatic or Manual record, and select main stream or sub stream.

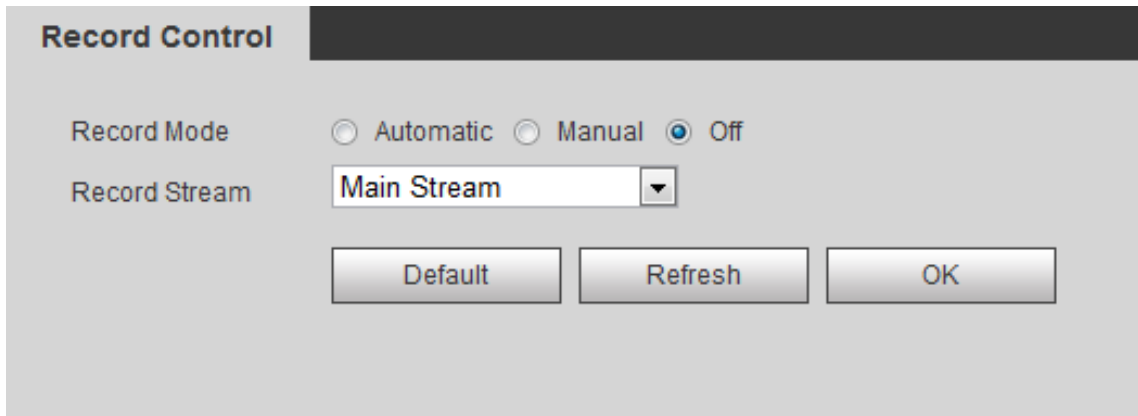

Figure 6-90 Record Control

Parameter	Note
Record Mode	select Automatic or Manual record or off.
Record Stream	select main stream or sub stream.

Chart 6-34

## 6.5.6 System

### 6.5.6.1 General

#### 6.5.6.1.1 General

The general interface is shown as in Figure 6-91 General.

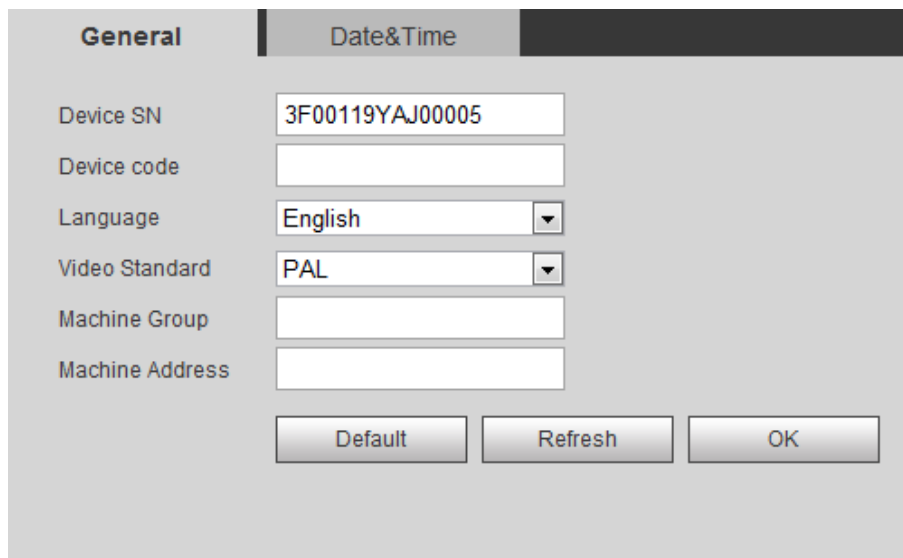

Figure 6-91 General

Please refer to the following sheet for log parameter information.

Parameter	Function
Device SN	Set the device number.
Device Code	Fill apparatus for encoding flag.
Language	Select language and then close IE. When you log in again, system language will change.
Video standard	Display device video standard, such as PAL.
Machine Group	Enter local device unit name.
Machine Address	Enter snapshot location.

Chart 6-35

### 6.5.6.1.2 Date&Time

The date&time interface is shown as in Figure 6-92 Date&Time.

The screenshot shows the 'Date&Time' configuration page. It includes the following elements:

- Tabs:** 'General' and 'Date&Time' (selected).
- Date Format:** Dropdown menu set to 'YYYY-MM-DD'.
- Time Format:** Dropdown menu set to '24-Hour'.
- Current Time:** Displayed as '2017 - 12 - 26 19 : 04 : 24' with a 'Sync PC' button.
- DST:** A checked checkbox labeled 'DST'.
- DST Type:** Radio buttons for 'Date' (selected) and 'Week'.
- Start Time:** Fields for month (Jan), day (1), and time (00 : 00 : 00).
- End Time:** Fields for month (Jan), day (2), and time (00 : 00 : 00).
- Check Time Mode:** Checkboxes for 'NTP' and 'Statellite'. A red note says 'Please enable positioning enabled, when using statellite to check time'.
- Server:** Text input field containing 'clock.isc.org'.
- Port:** Text input field containing '123'.
- Time Zone:** Dropdown menu set to 'GMT+08:00'.
- Interval:** Text input field containing '10' with the label 'min. (1~30)'.
- Buttons:** 'Default', 'Refresh', and 'OK' at the bottom.

Figure 6-92 Date&Time

Please refer to the following sheet for log parameter information.

Parameter	Function
Date format	Select date format.
Time format	Select time format.
Current time	Set current system time. Setup becomes effective immediately.
Sync PC	Sync system time with PC time. Click on save to refresh system time.
DST	Set DST, may by date or week. Setup becomes effective immediately.
NTP setup	Check to sync with NTP.
NTP server	Set NTP server address.
Port	Set NTP port no.
Time zone	Set device time zone.
Interval	Set device update period.

## 6.5.6.2 Account

### 6.5.6.2.1 Account

#### Rule

Note:

- Account has two levels as group and username. Group supports max of 8 and username supports max of 18. Default group includes admin and user.
- Group name cannot be repeated. Each user belongs to one group only. You may add and delete group and set group. User right within a group can be customized as long as within right of the group.
- Username and group names support max length of 15 characters which can be letter, number, underline and dash.

### 6.5.6.2.2 Username

The username interface is shown as in Figure 6-93 Username. Here you can add and delete username, and modify user password.

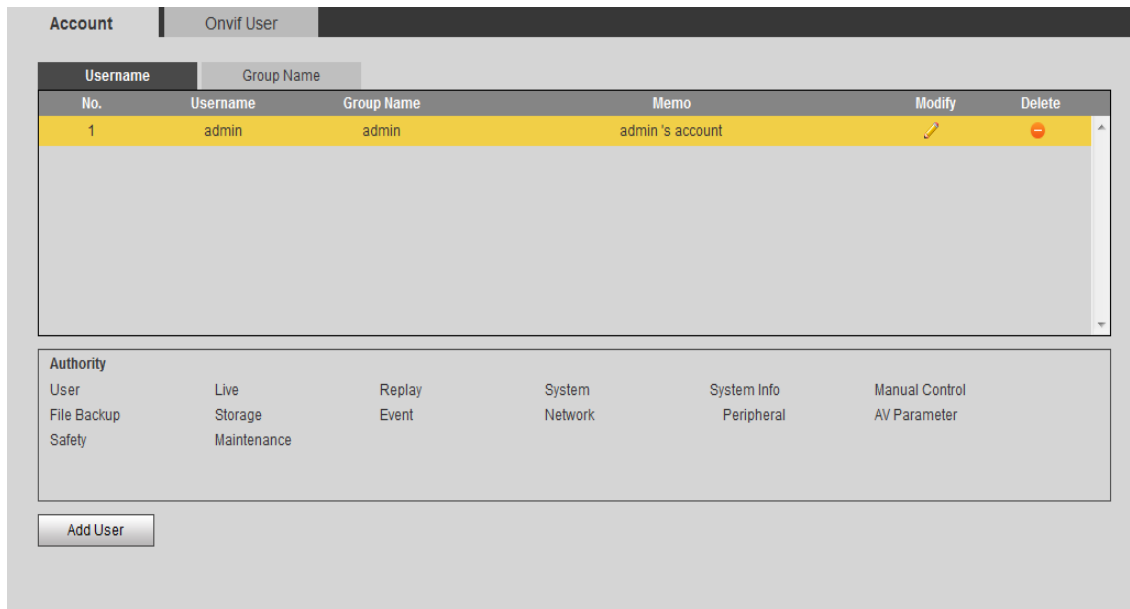

Figure 6-93 Username

Anonymous login: Enable anonymous login as input IP without username and password to log in device. This type of account only have preview right. You may switch to other account by clicking on logout.

Add user: Add user within group and set user right.

By default there are three users: admin, 888888 and 666666. Their passwords are the same as corresponding username. Admin and 888888 are admin account by default while 666666 is user account which has monitor right only.

Enter add user interface, input username and password, and select its group.

Username shall not exceed right of its group.

We recommend you to set user right lower than admin right.

The modify user interface is shown as in Figure 6-94 Modify User.

Figure 6-94 Modify User

Modify user: Modify existing user's group, password, right and note.

Modify password: Modify password of existing user. Check box in front of modify password. Input current password and then input new password. Click on save. Password supports 0~15 characters, including letter and number only.

Note:

- You cannot modify right of the logged in account.
- You cannot modify or delete admin, 888888 and 666666 accounts.
- Account who has right to modify other account, can modify other user account besides its own.
- You cannot delete currently logged in account.

### 6.5.6.2.3 Group

The group interface is shown as in Figure 6-95 Group. Here you can add and delete group, and modify group password.

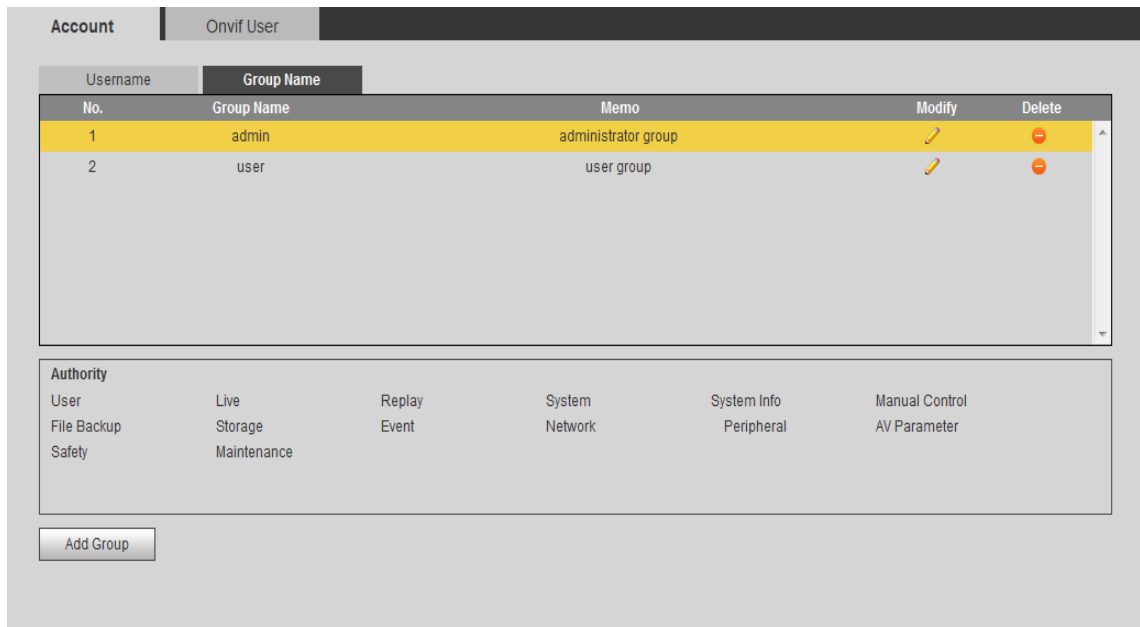

Figure 6-95 Group

Add group: Add user within group and set group right.

Note:

- You cannot delete admin and user groups.
- You cannot delete group which contains currently logged in user.

#### 6.5.6.2.4 ONVIF User

ONVIF user is separated from device user, so could be managed alone, see Figure 6-96.

Rule same as in Username.

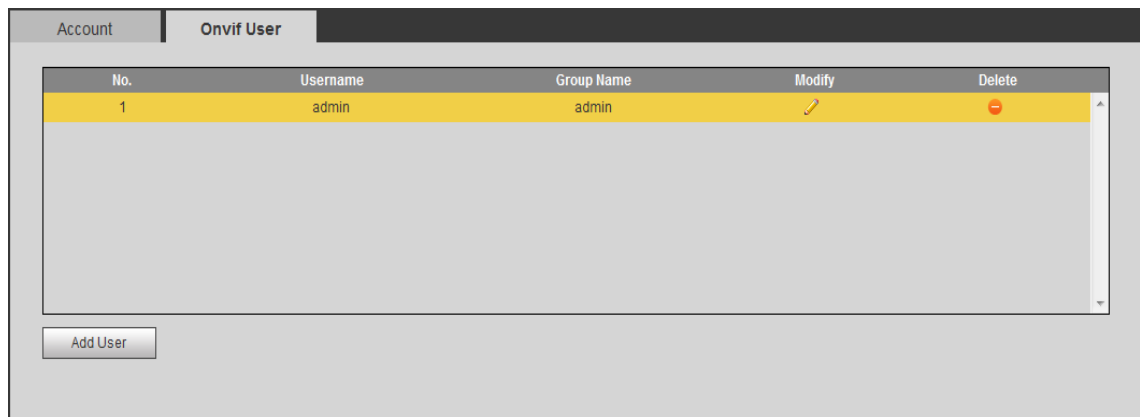
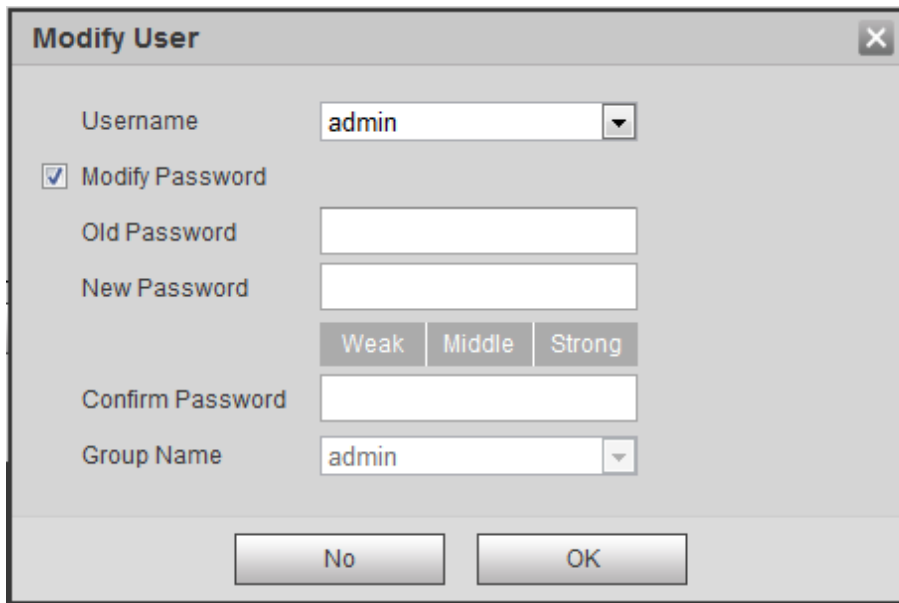

Figure 6-96

Click , see Figure 6-97.



The 'Modify User' dialog box contains the following fields and controls:

- Username:** A dropdown menu with 'admin' selected.
- Modify Password:** A checked checkbox.
- Old Password:** An empty text input field.
- New Password:** An empty text input field.
- Password Strength:** Three buttons labeled 'Weak', 'Middle', and 'Strong'.
- Confirm Password:** An empty text input field.
- Group Name:** A dropdown menu with 'admin' selected.
- Buttons:** 'No' and 'OK' buttons at the bottom.

Figure 6-97

### 6.5.6.3 Safety

#### 6.5.6.3.1 SSH

SSH is a protocol based on application and is reliable.

SSH server is OFF by default, you can select SSH Enable to enable it.

See Figure 6-98.

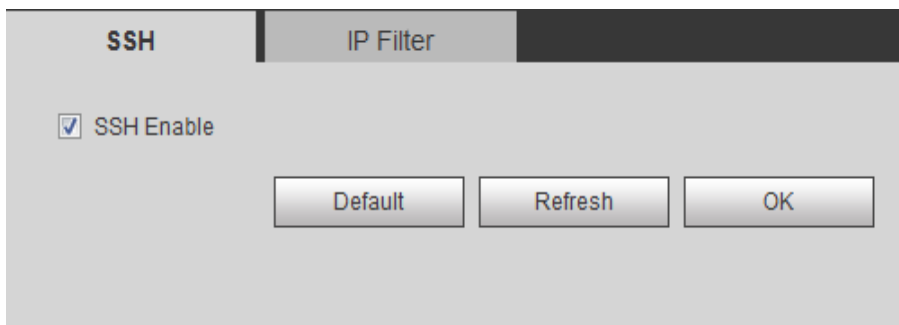

The SSH configuration interface shows the following elements:

- Tabs:** 'SSH' (selected) and 'IP Filter'.
- SSH Enable:** A checked checkbox.
- Buttons:** 'Default', 'Refresh', and 'OK' buttons at the bottom.

Figure 6-98

#### 6.5.6.3.2 IP Filter

You can add, delete Trust List and Banned List in IP Filter interface.

Select Setting>System>Safety>IP Filter, see Figure 6-99. Click Default to restore default setting, click OK to save.



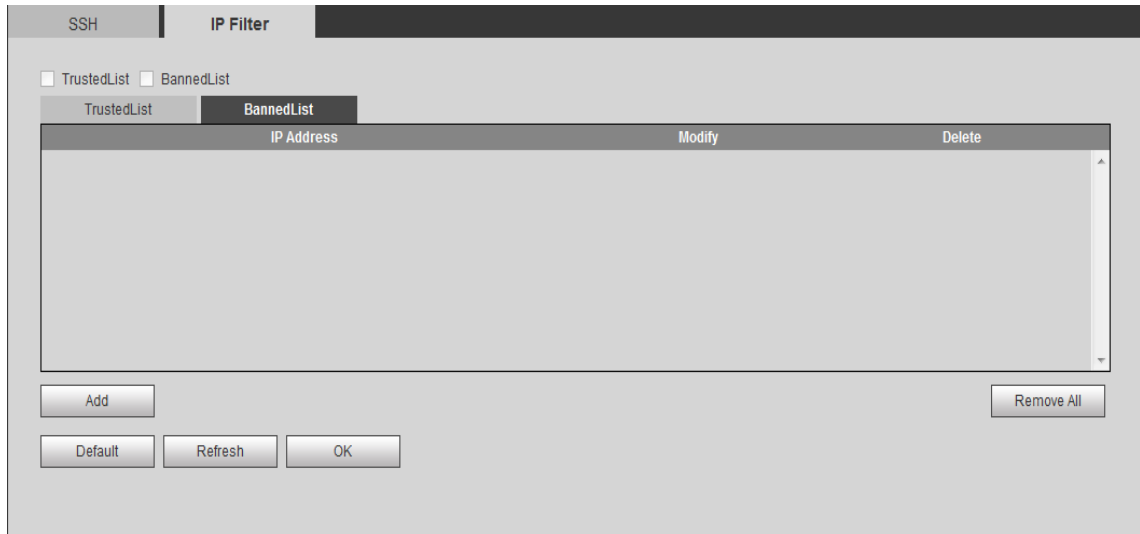

Figure 6-99

#### 6.5.6.4 Default

The default interface is shown as in Figure 6-100 Default.

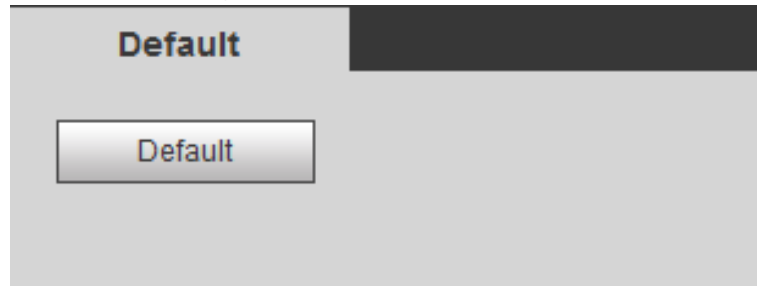

Figure 6-100 Default

Note:

- Network IP address, account info and system log cannot be restored to default.
- Each parameter of camera will be restored to default.

#### 6.5.6.5 Import/Export

The import/export interface is shown as in Figure 6-101 Import/Export.

Step 1. Select Setting>System>Import/Export.

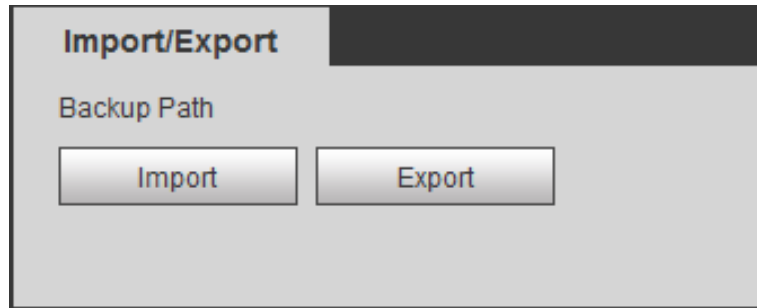

Figure 6-101 Import/Export

Step 2. Click Import or Export.

- Import: import local backup file to system.
- Export: export related config to local.

Note:

Import and export files are both in “.backup” format.

Step 3. Select import file path or folder to export.

#### 6.5.6.6 Auto Maintain

The auto maintains interface is shown as in Figure 6-102 Auto Maintain.

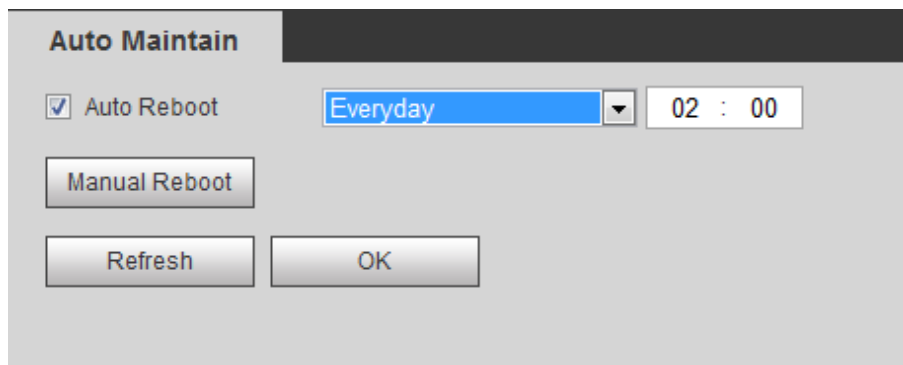

Figure 6-102 Auto Maintain

User can automatically reboot system and delete old files. You shall set auto reboot schedule and set file time period for auto delete old file to delete file within certain time periods. Click on save to make setup effective.

#### 6.5.6.7 Upgrade

When system upgrades, you shall select firmware file. Firmware file ends in \*.bin.

Please maintain stable power supply, connection and do not reboot or shut down camera during this process.

The upgrade interface is shown as in Figure 6-103 Upgrade.



Figure 6-103 Upgrade

**Note:** If system encounters error during upgrading, the device may malfunction.

## 6.5.7 Information

### 6.5.7.1 Version

The version interface is shown as in Figure 6-104 Version.  
Select Setting>Information>Version, to view current WEB version.

**Note:**

**Different device version has different info, subject to WEB.**

The image shows a web interface for viewing device version information. At the top, there is a dark header with the word "Version" in white. Below the header, there is a light gray area containing a list of device information. The information is presented in a table-like format with labels on the left and values on the right.

Device Type	ITC231-RF1A-IR
FPGA Version	
Hardware Version	1.00
Algorithm Version	libits v1.0.72809:Oct 20 2017 0.0.0
Software Version	2.401.0010.1.R, build : 2017-12-21
Soft Build Time	2017-12-21 08:48:08
WEB Version	3.1.6.91679
S/N	3F00119YAJ00005
CopyRight 2017,All Rights Reserved.	

Figure 6-104 Version

## 6.5.7.2 Log

### 6.5.7.2.1 Log

The log interface is shown as in Figure 6-105 Log.

The system supports filter by time, log type and etc. You can search log and back up log. Log type includes system operation, config operation, data operation, event operation, record operation, user management and safety management.

Step 1. Select Setting>Information>Log>Log.

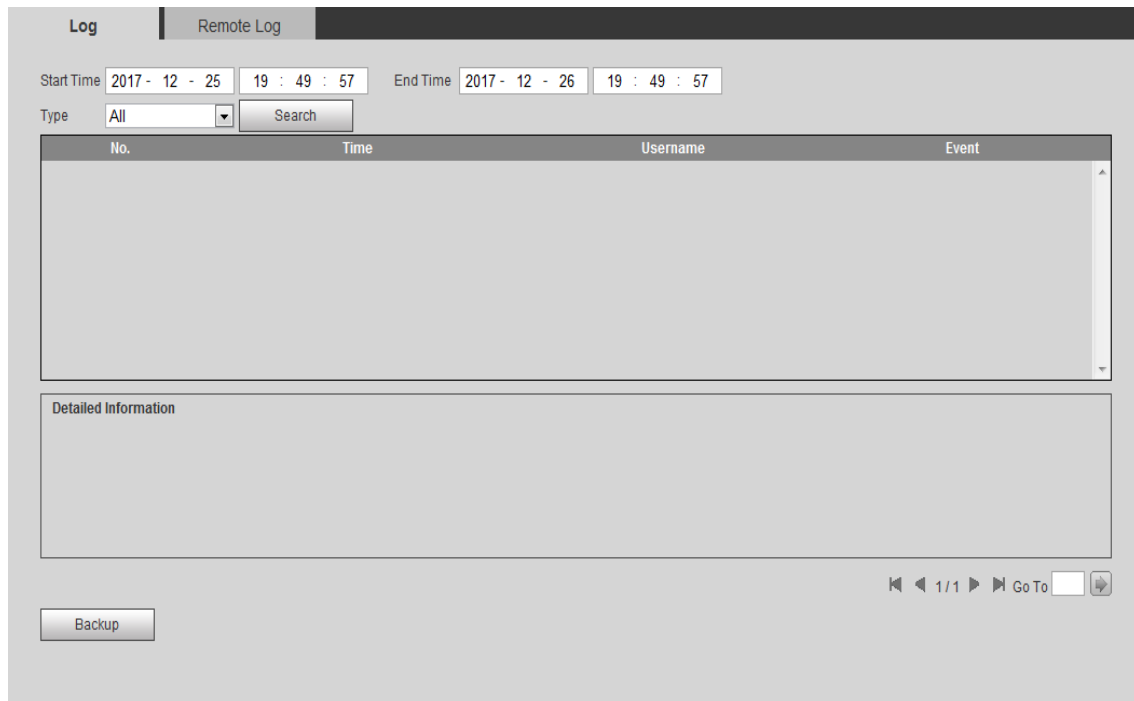

The screenshot shows a web interface for viewing logs. At the top, there are two tabs: "Log" (selected) and "Remote Log". Below the tabs, there are search filters: "Start Time" (2017 - 12 - 25 19 : 49 : 57), "End Time" (2017 - 12 - 26 19 : 49 : 57), and "Type" (All). A "Search" button is located to the right of the "Type" dropdown. Below the filters is a table with the following columns: "No.", "Time", "Username", and "Event". The table is currently empty. Below the table is a "Detailed Information" section, which is also empty. At the bottom right of the interface, there are navigation controls: a "Go To" field with a dropdown arrow, and a "Backup" button at the bottom left.

Figure 6-105 Log

Step 2. Enter start time, end time and select type.

Step 3. Click Search, you can stop search as you need.

Step 4. You can view search result and back up it.

Back up file will be stored at local in ".txt" format.

### 6.5.7.2.2 Remote Log

Remote log allows the device to save key login into network log server which is an important clue. Log server must be set by professional or system administrator.

Step 1. Select Setting>Information>Log>Remote Log, see Figure 6-106.

Log | **Remote Log**

Enable

IP Address: 192 . 168 . 0 . 108

Port: 514 (1~65534)

Device Number: 22 (0~23)

Default Refresh OK

Figure 6-106

Step 2. Select Enable to enable remote log function.

Step 3. Enter log server IP address, port, device number.

Step 4. Click OK.

### 6.5.7.3 Online User

The online user interface is shown as in Figure 6-107 Online User. Here displays online user and their group, IP address and login time.

No.	User Name	User Local Group	IP Address	User Login Time
1	admin	admin	10.15.6.95	2017-12-26 08:58:41
2	admin	admin	10.15.6.95	2017-12-26 08:58:46
3	admin	admin	10.15.6.95	2017-12-26 09:02:38
4	admin	admin	10.34.12.50	2017-12-26 19:15:57

Refresh

Figure 6-107 Online User

### 6.5.7.4 Work State

Go to Setting>Information>Work State.

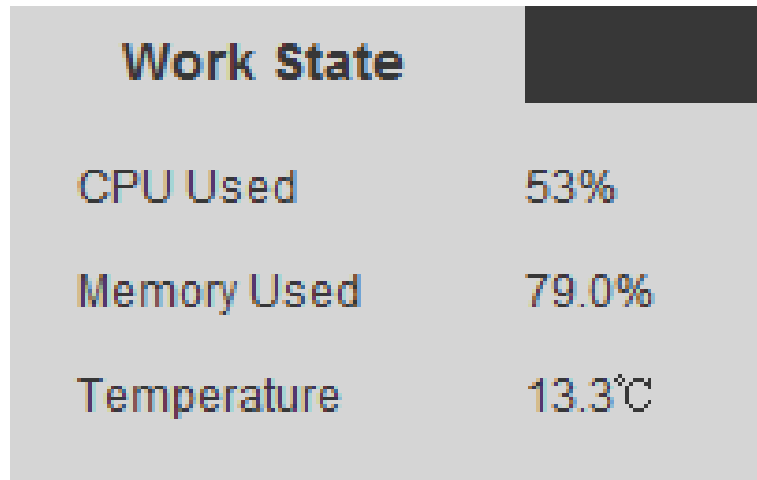

Figure 6-108

## 6.6 Alarm

In WEB interface, open alarm setup, here you can set alarm type and prompt. See Figure 6-109.

The screenshot shows the 'Alarm Type' configuration page. On the left, there are several sections: 'Alarm Type' with checkboxes for Storage Full, External Alarm, Black List, Parking, Pedestrian, Storage Error, No Storage, Gyro Abnormal Attitude, Retrograde, and Illegal Access; 'Operation' with a Listen Alarm checkbox; and 'Alarm Tone' with a Play Alarm Tone checkbox and a Tone Path field with a Browse button. On the right, there is a table with columns for 'No.', 'Time', 'Alarm Type', and 'Channels No.'.

Figure 6-109

Type	Parameter	Note
Alarm Type	Storage Full	When storage is full, trigger alarm
	Storage Error	When storage has error, trigger alarm
	External Alarm	Alarm input device alarm
	No Storage	No storage and trigger alarm
	Black List	Detect plate in blacklist, trigger alarm.
	Gyro Abnormal Attitude	When device attitude has abnormality, trigger alarm.

Type	Parameter	Note
	Parking	Illegal parking , trigger alarm
	Retorgrade	Retrograde, trigger alarm
	Pedstrain	When pedestrian occurs, trigger alarm
	Illegal Access	Detect illegal access, trigger alarm
Operation	Listen Alarm	WEB subscribed alarm type selected above from device, and device will notify WEB by alarm and WEB notify users.
Alarm Tome	Play Alarm Tone	Alarm has tone, you can customize alarm sound
	Tone Path	Customize alarm sound storage path.

Chart 6-36

## 6.7 Logout

Click Logout to log out. See Figure 6-110.

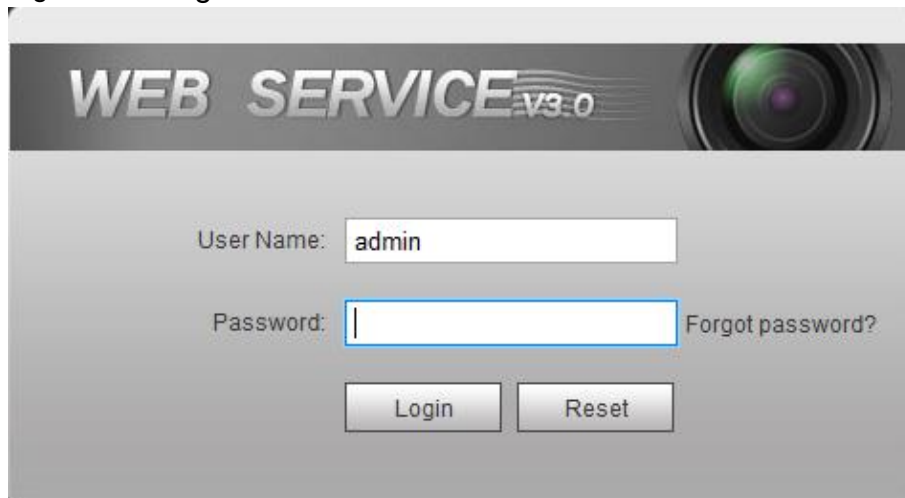

The screenshot shows a web interface for 'WEB SERVICE v3.0'. At the top, there is a dark banner with the text 'WEB SERVICE v3.0' and a camera lens icon on the right. Below the banner, the login form is displayed on a light gray background. It consists of the following elements:

- User Name:** A text input field containing the text 'admin'.
- Password:** A text input field that is currently empty.
- Forgot password?:** A text link located to the right of the password field.
- Login:** A button located below the user name and password fields.
- Reset:** A button located to the right of the Login button.

Figure 6-110

## 7 FAQ

Bug	Solution
I cannot boot up the device.	Please click RESET button for at least five seconds to restore factory default setup.
TF card hot swap	Before draw out TF card, please stop record or snapshot first and then wait for at least 15 seconds to remove the TF card. All the operations before is to maintain data integrity.
TF card write times	Do not set the TF card as the storage media to storage the schedule record file. It may damage the TF card duration.
I cannot use the disk as the storage media.	When disk information is shown as hibernation or capacity is 0, please format it first (Via Web).
I cannot upgrade the device via network.	The status indication light is shown as red when network upgrade operation failed. You can use port 3800 to continue upgrade.
Recommended TF card brand	Kingston 4GB, Kingston 1GB, Kingston 16GB, Transcend 16GB, SanDisk 1G, SanDisk 4G Usually we recommend the 4GB (or higher) high speed card in case the slow speed results in data loss.
Web control webrec.cab not pop up	Please set IE security level to low and enable ActiveX plug-in.

### Warning:

This version of explorer supports win10+IE11, Chrome and Firefox explorers in Windows system.

### Note:

- This manual is for reference only. Slight difference may be found in the user interface.
- All the designs and software here are subject to change without prior written notice.
- All trademarks and registered trademarks mentioned are the properties of their respective owners.
- If there is any uncertainty or controversy, please refer to the final explanation of us.
- Please visit our website or contact your local retailer for more information.



**ZHEJIANG DAHUA VISION TECHNOLOGY CO.,LTD.**

No.1199, Bin'an Road, Binjiang District, Hangzhou, P.R. China

Postcode: 310053

Tel: +86-571-87688883

Fax: +86-571-87688815

Email: [overseas@dahuatech.com](mailto:overseas@dahuatech.com)

Website: [www.dahuatech.com](http://www.dahuatech.com)